

### Product Summary (Per Leg)

V <sub>RRM</sub> (V)	I <sub>O</sub> (A)	V <sub>F</sub> (TYP) (V) @ +25°C	I <sub>R</sub> (MAX) (mA) @ +25°C
100	20	0.61	0.5

### Description and Applications

Packaged in the robust industry-standard TO220AB and ITO-220AB packages, the SBRTF40U100CT and SBRTF40U100CTFP provide ultra low V<sub>F</sub> and excellent reverse leakage stability at high temperatures. It is ideal for use as a rectifier, freewheel diode or blocking diode in:

- DC-DC Converters
- AC-DC Adaptors

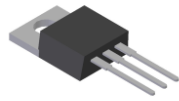

TO220AB  
Top View

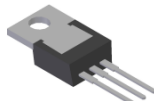

TO220AB  
Bottom

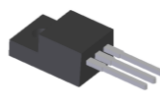

ITO-220AB  
Top View

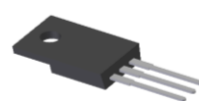

ITO-220AB  
Bottom View

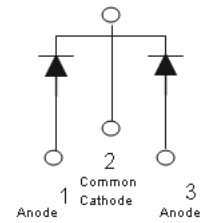

Package Pin-Out  
Configuration

### Features and Benefits

- Reduced Ultra-low Forward Voltage Drop (V<sub>F</sub>)  
Better Efficiency. V<sub>F</sub>=0.34V at I<sub>F</sub>=5A
- Avalanche Rated
- **Lead-Free Finish; RoHS Compliant (Notes 1 & 2)**
- **Halogen and Antimony Free. "Green" Device (Note 3)**

### Mechanical Data

- Case: TO220AB, ITO-220AB
- Case Material: Molded Plastic, "Green" Molding Compound.  
UL Flammability Classification Rating 94V-0
- Moisture Sensitivity: Level 1 per J-STD-020
- Terminals: Matte Tin Finish.  
Solderable per MIL-STD-202, Method 208
- Weight
  - TO220AB – 1.85 grams (Approximate)
  - ITO-220AB – 1.65 grams (Approximate)

### Ordering Information (Note 4)

Part Number	Case	Packaging
SBRTF40U100CT	TO220AB	50 pieces/tube
SBRTF40U100CTFP	ITO-220AB	50 pieces/tube

- Notes:
1. EU Directive 2002/95/EC (RoHS) & 2011/65/EU (RoHS 2) compliant. All applicable RoHS exemptions applied.
  2. See [http://www.diodes.com/quality/lead\\_free.html](http://www.diodes.com/quality/lead_free.html) for more information about Diodes Incorporated's definitions of Halogen- and Antimony-free, "Green" and Lead-free.
  3. Halogen- and Antimony-free "Green" products are defined as those which contain <900ppm bromine, <900ppm chlorine (<1500ppm total Br + Cl) and <1000ppm antimony compounds.
  4. For packaging details, go to our website at <http://www.diodes.com/products/packages.html>.

### Marking Information

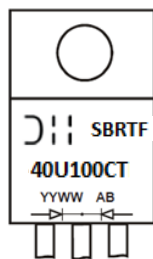

SBRTF40U100CT = Product Type Marking Code  
AB = Foundry and Assembly Code  
YYWW = Date Code Marking  
YY = Last Two Digits of Year (ex: 15 = 2015)  
WW = Week (01-53)

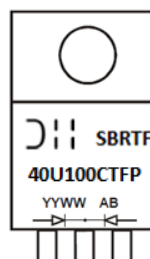

SBRTF40U100CTFP = Product Type Marking Code  
AB = Foundry and Assembly Code  
YYWW = Date Code Marking  
YY = Last Two Digits of Year (ex: 15 = 2015)  
WW = Week (01-53)

**Maximum Ratings** (@T<sub>A</sub> = +25°C, unless otherwise specified.)

Characteristic	Symbol	Value	Unit
Peak Repetitive Reverse Voltage	V <sub>RRM</sub>	100	V
Average Rectified Output Current (Per Leg) (Total)	I <sub>O</sub>	20 40	A
Non-Repetitive Peak Forward Surge Current 8.3ms Single Half Sine-Wave Superimposed on Rated Load (Per Leg)	I <sub>FSM</sub>	200	A
Peak Avalanche Power (1μs, +25°C)	P <sub>ARM</sub>	10,000	W
Non-Repetitive Avalanche Energy (T <sub>J</sub> = +25°C, I <sub>AS</sub> = 9A, L = 10mH)	E <sub>AS</sub>	340	mJ

**Thermal Characteristics (Per Leg)**

Characteristic	Symbol	Value	Unit
Typical Thermal Resistance			
TO220AB (Note 5)	R <sub>θJA</sub>	55	°C/W
TO220AB (Note 6)	R <sub>θJC</sub>	1	
TO220AB (Note 6)	R <sub>θJA</sub>	7	
ITO-220AB (Note 5)	R <sub>θJA</sub>	45	
ITO-220AB (Note 6)	R <sub>θJC</sub>	1.6	
ITO-220AB (Note 6)	R <sub>θJA</sub>	11	
Operating and Storage Temperature Range	T <sub>J</sub> , T <sub>STG</sub>	-55 to +150	°C

**Electrical Characteristics (Per Leg)** (@T<sub>A</sub> = +25°C, unless otherwise specified.)

Characteristic	Symbol	Min	Typ	Max	Unit	Test Condition
Forward Voltage Drop (Note 7)	V <sub>F</sub>	—	0.40	—	V	I <sub>F</sub> = 5A, T <sub>J</sub> = +25°C
		—	0.48	0.58		I <sub>F</sub> = 10A, T <sub>J</sub> = +25°C
		—	0.61	0.68		I <sub>F</sub> = 20A, T <sub>J</sub> = +25°C
		—	0.34	—		I <sub>F</sub> = 5A, T <sub>J</sub> = +125°C
		—	—	0.65		I <sub>F</sub> = 20A, T <sub>J</sub> = +125°C
Leakage Current (Note 7)	I <sub>R</sub>	—	0.08	0.25	mA	V <sub>R</sub> = 90V, T <sub>J</sub> = +25°C
		—	0.15	0.5		V <sub>R</sub> = 100V, T <sub>J</sub> = +25°C
		—	—	30		V <sub>R</sub> = 80V, T <sub>J</sub> = +125°C
		—	35	—		V <sub>R</sub> = 100V, T <sub>J</sub> = +125°C
Junction Capacitance	C <sub>J</sub>	—	250	—	pF	V <sub>R</sub> = 40V, f = 1.0MHz

- Notes:
5. Test with no additional heatsink.
  6. Test with additional heatsink (Aluminum, 50 x 50 x 23mm).
  7. Short duration pulse test used to minimize self-heating effect.

NEW PRODUCT

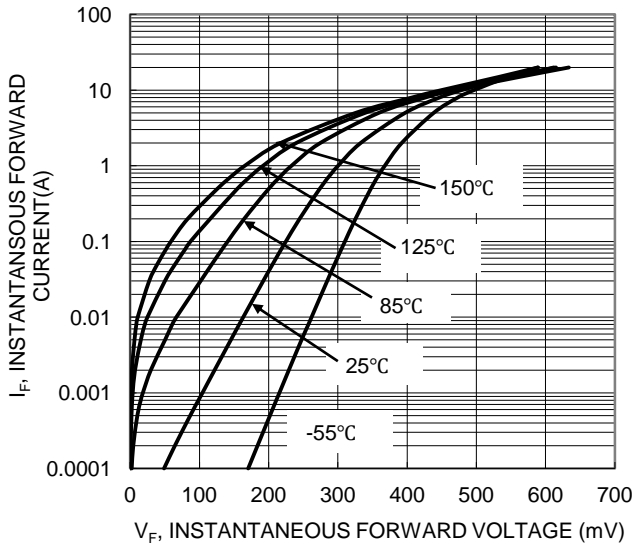

Figure 1. Typical Forward Characteristics

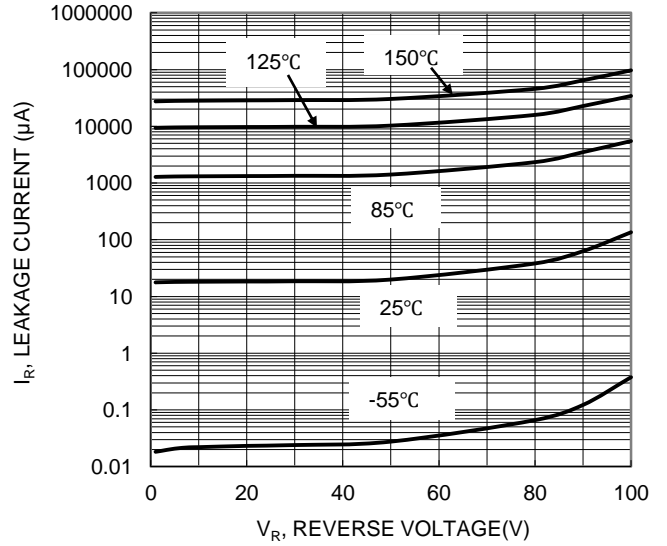

Figure 2. Typical Reverse Characteristics

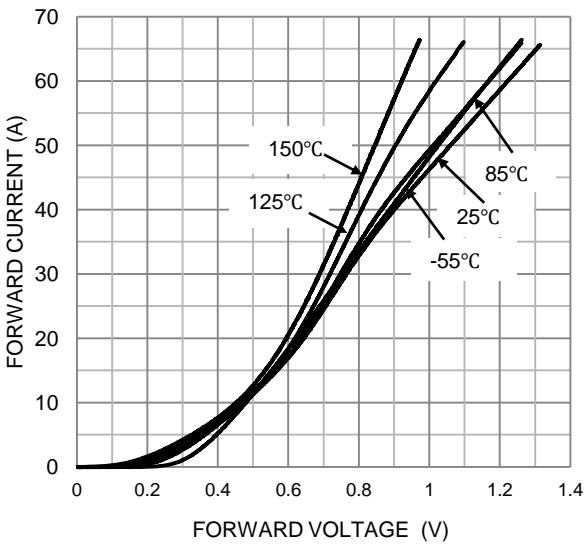

Figure 3. High Current Forward Characteristics

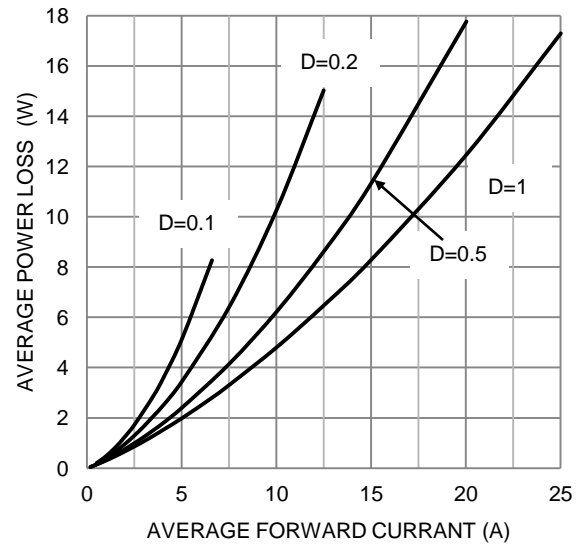

Figure 4. Forward Power Loss Characteristics Per Diode  $T=25^{\circ}\text{C}$

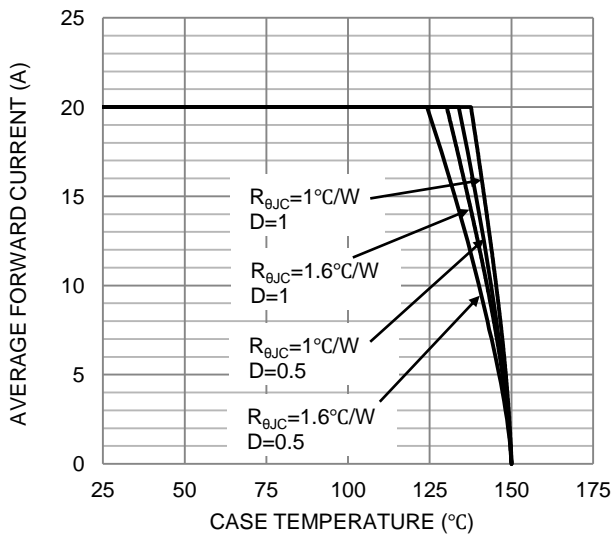

Figure 5. Current Derating per Leg

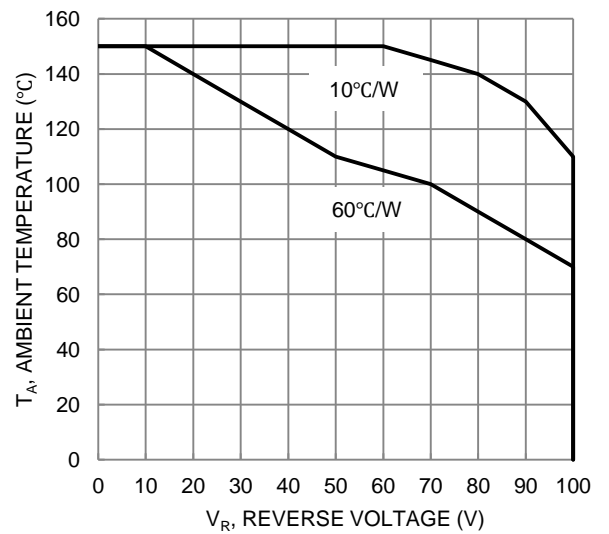
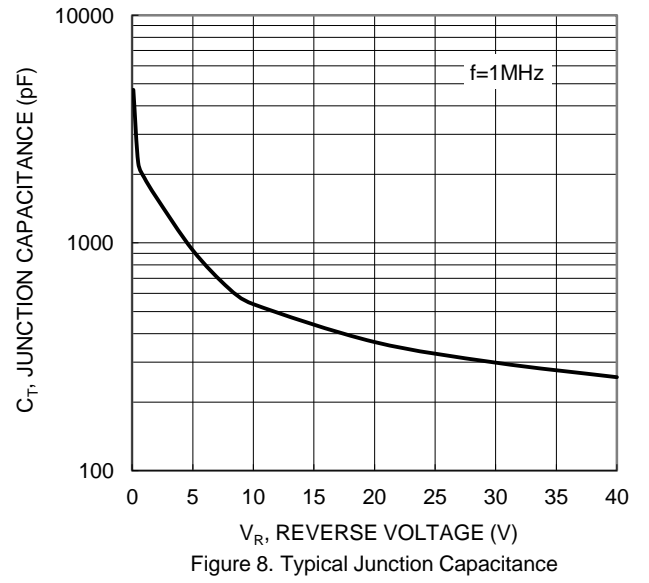
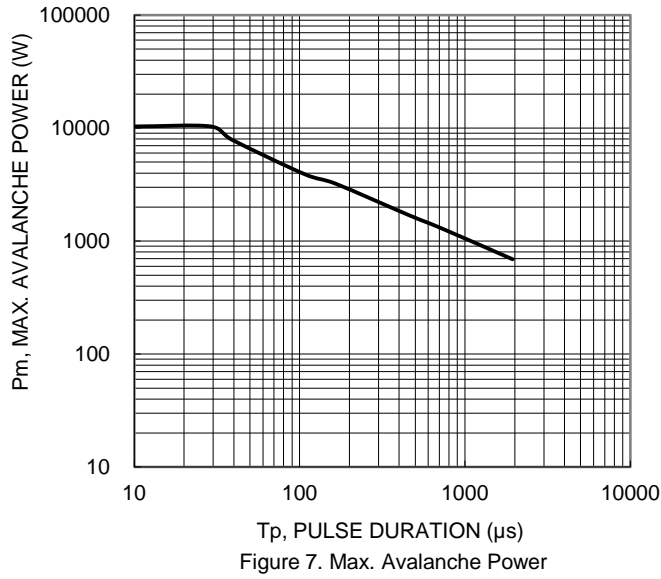

Figure 6. Reverse Safe Operating Area



**Package Outline Dimensions**

Please see AP02002 at <http://www.diodes.com/datasheets/ap02002.pdf> for the latest version.

**(1) Package Type: TO220AB**

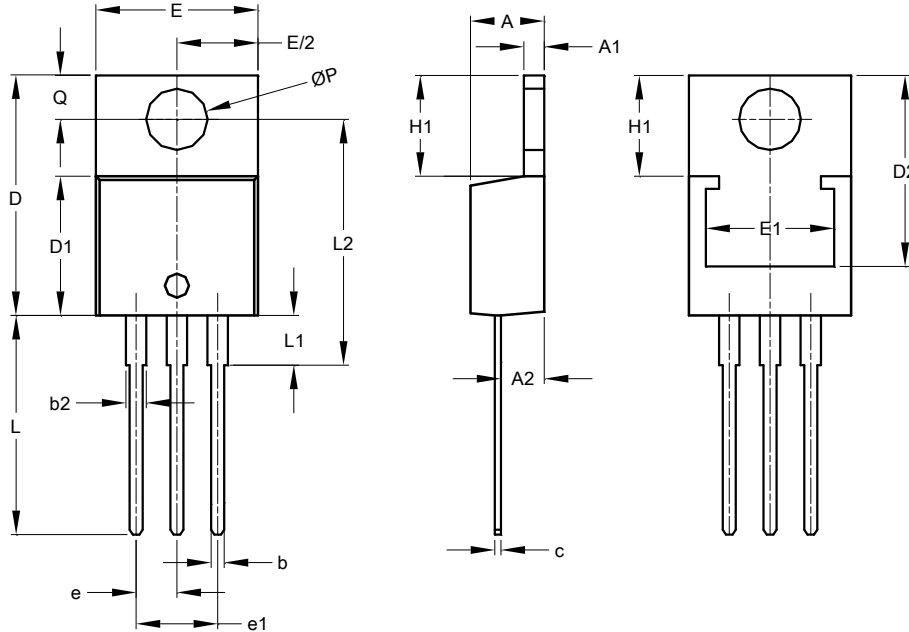

TO220AB				
Dim	Min	Max	Typ	
A	3.56	4.82	-	
A1	0.51	1.39	-	
A2	2.04	2.92	-	
b	0.39	1.01	0.81	
b2	1.15	1.77	1.24	
c	0.356	0.61	-	
D	14.22	16.51	-	
D1	8.39	9.01	-	
D2	11.45	12.87	-	
e	-	-	2.54	
e1	-	-	5.08	
E	9.66	10.66	-	
E1	6.86	8.89	-	
H1	5.85	6.85	-	
L	12.70	14.73	-	
L1	-	6.35	-	
L2	15.80	16.20	16.00	
P	3.54	4.08	-	
Q	2.54	3.42	-	
All Dimensions in mm				

**(2) Package Type: ITO-220AB**

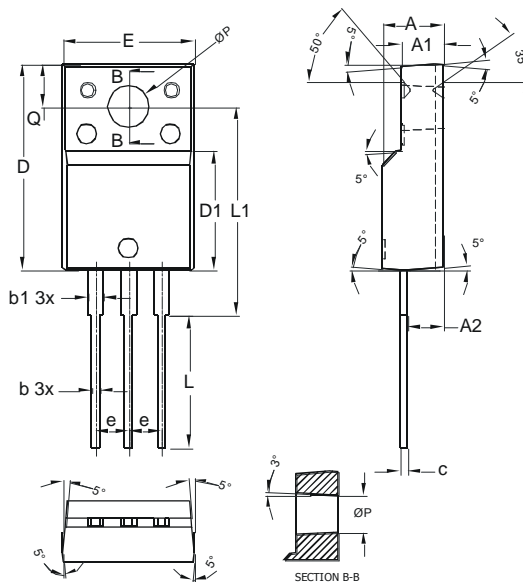

ITO-220AB			
Dim	Min	Typ	Max
A	4.50	4.70	4.90
A1	3.04	3.24	3.44
A2	2.56	2.76	2.96
b	0.50	0.60	0.75
b1	1.10	1.20	1.35
c	0.50	0.60	0.70
D	15.67	15.87	16.07
D1	8.99	9.19	9.39
e	2.54		
E	9.91	10.11	10.31
L	9.45	9.75	10.05
L1	15.80	16.00	16.20
P	2.98	3.18	3.38
Q	3.10	3.30	3.50
All Dimensions in mm			

NEW PRODUCT

**IMPORTANT NOTICE**

DIODES INCORPORATED MAKES NO WARRANTY OF ANY KIND, EXPRESS OR IMPLIED, WITH REGARDS TO THIS DOCUMENT, INCLUDING, BUT NOT LIMITED TO, THE IMPLIED WARRANTIES OF MERCHANTABILITY AND FITNESS FOR A PARTICULAR PURPOSE (AND THEIR EQUIVALENTS UNDER THE LAWS OF ANY JURISDICTION).

Diodes Incorporated and its subsidiaries reserve the right to make modifications, enhancements, improvements, corrections or other changes without further notice to this document and any product described herein. Diodes Incorporated does not assume any liability arising out of the application or use of this document or any product described herein; neither does Diodes Incorporated convey any license under its patent or trademark rights, nor the rights of others. Any Customer or user of this document or products described herein in such applications shall assume all risks of such use and will agree to hold Diodes Incorporated and all the companies whose products are represented on Diodes Incorporated website, harmless against all damages.

Diodes Incorporated does not warrant or accept any liability whatsoever in respect of any products purchased through unauthorized sales channel. Should Customers purchase or use Diodes Incorporated products for any unintended or unauthorized application, Customers shall indemnify and hold Diodes Incorporated and its representatives harmless against all claims, damages, expenses, and attorney fees arising out of, directly or indirectly, any claim of personal injury or death associated with such unintended or unauthorized application.

Products described herein may be covered by one or more United States, international or foreign patents pending. Product names and markings noted herein may also be covered by one or more United States, international or foreign trademarks.

This document is written in English but may be translated into multiple languages for reference. Only the English version of this document is the final and determinative format released by Diodes Incorporated.

**LIFE SUPPORT**

Diodes Incorporated products are specifically not authorized for use as critical components in life support devices or systems without the express written approval of the Chief Executive Officer of Diodes Incorporated. As used herein:

A. Life support devices or systems are devices or systems which:

1. are intended to implant into the body, or
2. support or sustain life and whose failure to perform when properly used in accordance with instructions for use provided in the labeling can be reasonably expected to result in significant injury to the user.

B. A critical component is any component in a life support device or system whose failure to perform can be reasonably expected to cause the failure of the life support device or to affect its safety or effectiveness.

Customers represent that they have all necessary expertise in the safety and regulatory ramifications of their life support devices or systems, and acknowledge and agree that they are solely responsible for all legal, regulatory and safety-related requirements concerning their products and any use of Diodes Incorporated products in such safety-critical, life support devices or systems, notwithstanding any devices- or systems-related information or support that may be provided by Diodes Incorporated. Further, Customers must fully indemnify Diodes Incorporated and its representatives against any damages arising out of the use of Diodes Incorporated products in such safety-critical, life support devices or systems.

Copyright © 2015, Diodes Incorporated

[www.diodes.com](http://www.diodes.com)