

# Fast Switching SCR T7SH\_40

400A Avg.  
(700 RMS)  
Up to 1200 Volts  
10-50  $\mu$ s

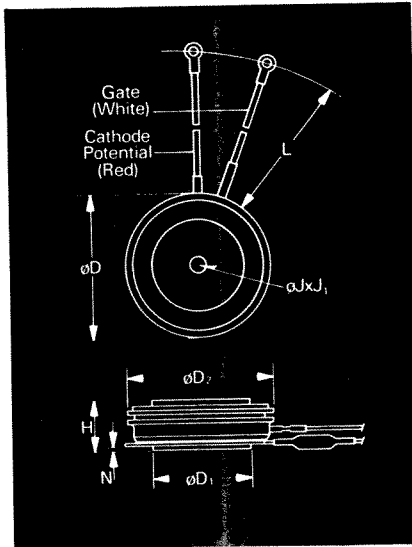

Symbol	Inches		Millimeters	
	Min.	Max.	Min.	Max.
$\phi D$	1.850	1.900	45.72	48.26
$\phi D_1$	1.140	1.180	28.96	29.97
$\phi D_2$	1.760	1.850	44.70	46.99
H	.545	.605	13.84	15.37
$\phi J$	.135	.145	3.43	3.68
$J_1$	.072	.082	1.83	2.08
L	7.75	8.50	196.85	215.90
N	.025		.64	

Creep Distance—.41 in. min. (10.41 mm).  
Strike Distance—.35 in. min. (8.89 mm).  
Finish-Nickel Plate.  
Approx. Weight—4 oz. (113 g.)  
1. Dimension "H" is a clamped dimension.

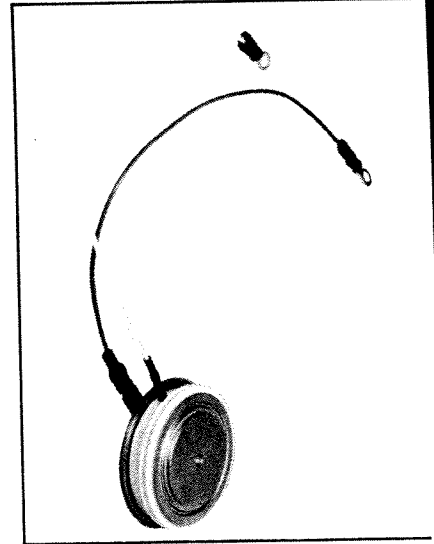

## T7S Outline

### Features:

- Interdigitated, di/namic Gate structure
- Hard Commutation Turn-Off
- Forward Blocking Voltage Capabilities to 1200 Volts
- Low Switching Losses at High Frequency
- Soft Commutation (Feedback Diode) Testing Available
- High di/dt with softgate control

### Applications:

- Induction Heating
- Transportation
- Inverters
- Crowbars
- Cycloconverters

## Ordering Information

Type	Voltage		Current		Turn-off		Gate current		Leads			
	Code	$V_{DRM}$ and $V_{RRM}$ (V)	Code	$I_{T(av)}$ (A)	Code	$t_q$ usec	Code	$I_{GT}$ (ma)	Code	Case		
T7SH		100	01	400	40	10	8	150	4	T7S	DN	
		200	02			15						7
		300	03			20						6
		400	04			25						5
		500	05			30						4
		600	06			40						3
		700	07			50						
		800	08									
		900	09									
		1000	10									
		1100	11									
		1200	12									

## Example

Obtain optimum device performance for your application by selecting proper Order Code.

Type T72H rated at 400A average with  $V_{DRM} = 1000V$ ,  
 $I_{GT} = 150$  ma,  $t_q = 30$   $\mu$ sec max. and leads—order as:

Type	Voltage	Current	Turn Off	Gate Current	Leads
T 7 S H	1 0	4 0	5	4	D N

**400A Avg.  
(700 RMS)  
Up to 1200 Volts  
10-50  $\mu$ s**

**Fast Switching  
SCR  
T7SH\_40**

**Voltage** ②

Blocking State Maximums ( $T_J = 125^\circ\text{C}$ )

Repetitive peak forward blocking voltage, V .....  $V_{DRM}$   
 Repetitive peak reverse voltage, V .....  $V_{RRM}$   
 Non-repetitive transient peak reverse voltage,  
 $t \leq 5.0$  msec, V .....  $V_{RSM}$   
 Forward leakage current, mA peak .....  $I_{DRM}$   
 Reverse leakage current, mA peak .....  $I_{RRM}$

Symbol

100	200	300	400	500	600	700	800	900	1000	1100	1200	
100	200	300	400	500	600	700	800	900	1000	1100	1200	
200	300	400	500	600	700	800	900	1000	1100	1200	1300	
							35					
							35					

**Current**

Conducting State Maximums  
( $T_J = 125^\circ\text{C}$ )

Symbol

**T7SH\_40**

RMS forward current, A ..... $I_T(\text{rms})$	628
Ave. forward current, A ..... $I_T(\text{av})$	400
One-half cycle surge current③, A ..... $I_{TSM}$	8000
3 cycle surge current③, A ..... $I_{TSM}$	5765
10 cycle surge current③, A ..... $I_{TSM}$	4980
$I^2t$ for fusing (for times $\geq 8.3$ ms) A <sup>2</sup> sec. .... $I^2t$	267,000
Forward voltage drop at $I_{TM} = 1500\text{A}$ and $T_J = 25^\circ\text{C}$ , V ..... $V_{TM}$	3.15
Min. repetitive $di/dt$ ①④⑤ A/ $\mu$ sec .... $di/dt$	500

**Switching**

( $T_J = 25^\circ\text{C}$ )

Symbol

Max. turn-off time, $I_T = 1000\text{A}$ , $T_J = 125^\circ\text{C}$ $t_p = 100$ $\mu$ sec. $dirR/dt = 50$ A/ $\mu$ sec., reapplied $dv/dt =$ $200\text{V}/\mu$ sec. linear to $0.8 V_{DRM}$ , $\mu$ sec. ①② $t_q$	10 to 50
Typ. delay time, $I_{TM} = 1000\text{A}$ $T_D = .8 V_{DRM}$ ③, $\mu$ sec $t_d$	.5
Min. critical $dv/dt$ exponential to .8 $V_{DRM}$ , $T_J = 125^\circ\text{C}$ , V/ $\mu$ sec ②③ $dv/dt$	300
Min. $di/dt$ , non-repetitive, A/ $\mu$ sec ①④⑤ $di/dt$	1200

**Gate**

Maximum Parameters  
( $T_J = 25^\circ\text{C}$ )

Symbol

Gate current to trigger at $V_D = 12\text{V}$ , mA $I_{GT}$	150
Gate voltage to trigger at $V_D = 12\text{V}$ , V ..... $V_{GT}$	3
Non-triggering gate voltage, $T_J = 125^\circ\text{C}$ , and rated $V_{DRM}$ , V ..... $V_{GDM}$	.25
Peak forward gate current, A ..... $I_{GTM}$	4
Peak reverse gate voltage, V ..... $V_{GRM}$	5
Peak gate power, Watts ..... $P_{GM}$	16
Average gate power, Watts ..... $P_{G(\text{av})}$	3

**Thermal and Mechanical**

Symbol

Min., Max. oper. junction temp., $^\circ\text{C}$ ..... $T_J$	-40 to +125
Min., Max. storage temp., $^\circ\text{C}$ ..... $T_{stg}$	-40 to +150
Max. mounting force, lb. .... ①	2000 to 2400
Thermal resistance④, double- side cooling, junction to case, $^\circ\text{C}/\text{Watt}$ ..... $R_{\theta JC}$	.045
Case to sink, lubricated, $^\circ\text{C}/\text{Watt}$ ..... $R_{\theta CS}$	.02

- ① Consult recommended mounting procedures.
- ② Applies for zero or negative gate bias.
- ③ Per JEDEC RS-397, 5.2.2.1.
- ④ With recommended gate drive.
- ⑤ Higher  $dv/dt$  ratings available, consult factory.
- ⑥ Per JEDEC standard RS-397, 5.2.2.6.
- ⑦ For operation with antiparallel diode, consult factory.

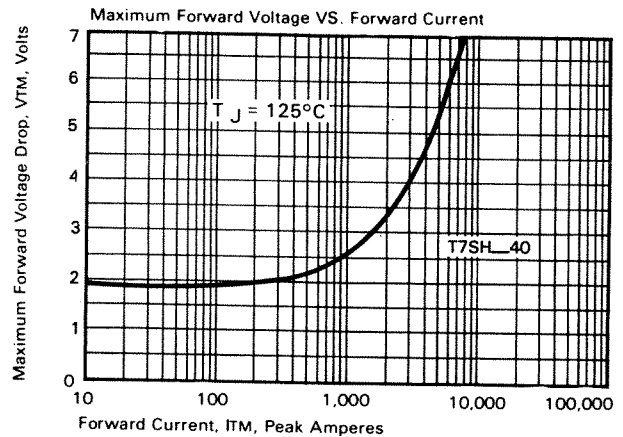

Transient Thermal Impedance VS. Time

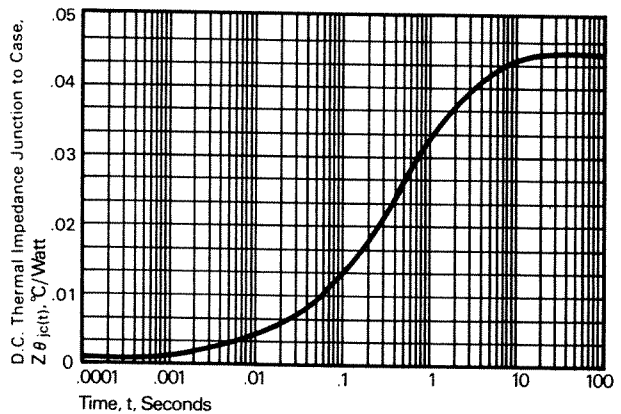

# Fast Switching SCR T7SH\_40

400A Avg.  
(700 RMS)  
Up to 1200 Volts  
10-50  $\mu$ s

## Sinusoidal Current Data

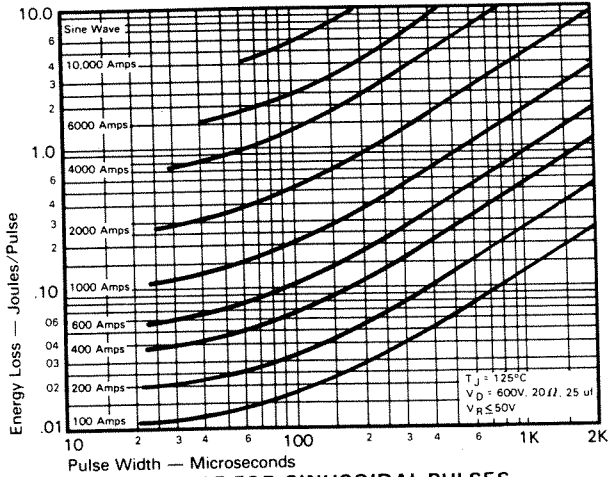

ENERGY PER PULSE FOR SINUSOIDAL PULSES

## Trapezoidal Wave Current Data

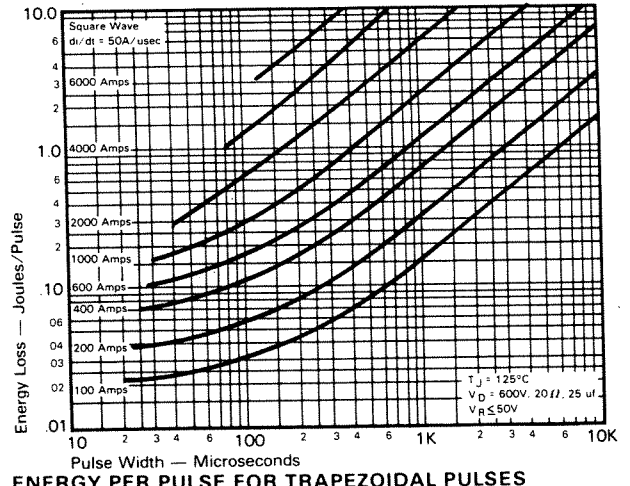

ENERGY PER PULSE FOR TRAPEZOIDAL PULSES  
( $di/dt = 50\text{A}/\text{usec}$ )

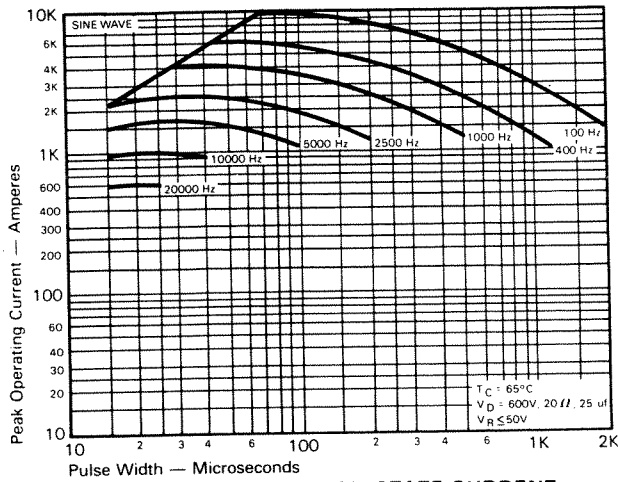

MAXIMUM ALLOWABLE PEAK ON-STATE CURRENT  
vs. PULSE WIDTH ( $T_C = 65^\circ\text{C}$ )

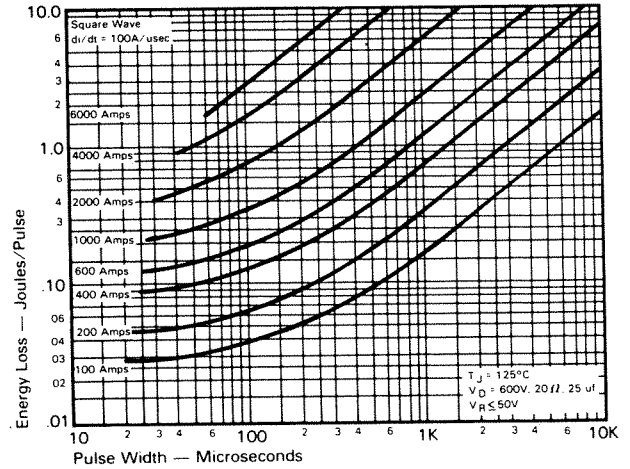

ENERGY PER PULSE FOR TRAPEZOIDAL PULSES  
( $di/dt = 100\text{A}/\text{usec}$ )

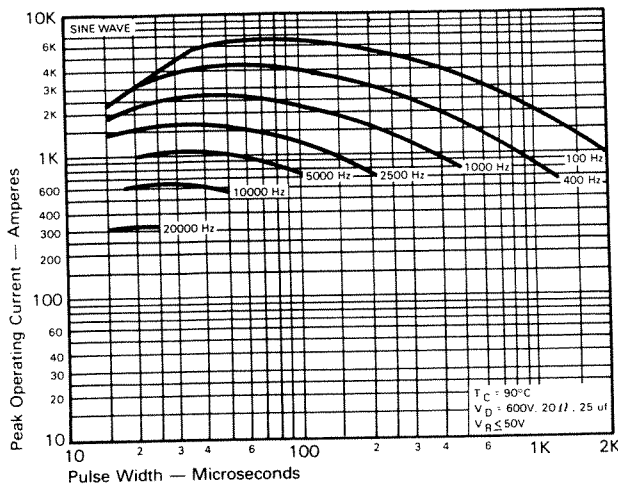

MAXIMUM ALLOWABLE PEAK ON-STATE CURRENT  
vs. PULSE WIDTH ( $T_C = 90^\circ\text{C}$ )

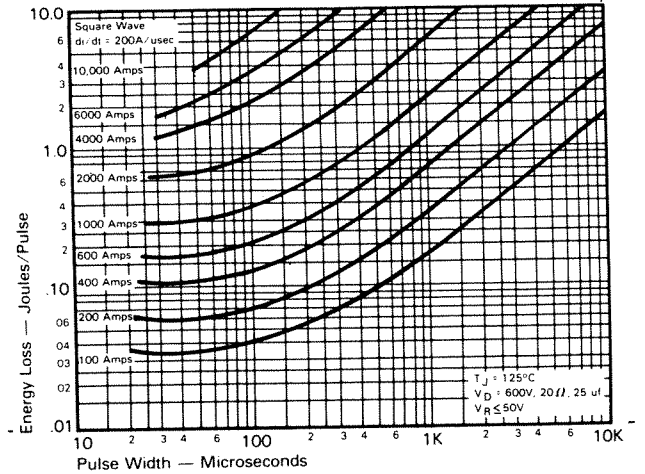

ENERGY PER PULSE FOR TRAPEZOIDAL PULSES  
( $di/dt = 200\text{A}/\text{usec}$ )

**400A Avg.  
(700 RMS)  
Up to 1200 Volts  
10-50  $\mu$ s**

**Fast Switching  
SCR  
T7SH\_40**

**Trapezoidal Wave Current Data  
( $T_C = 65^\circ\text{C}$ )**

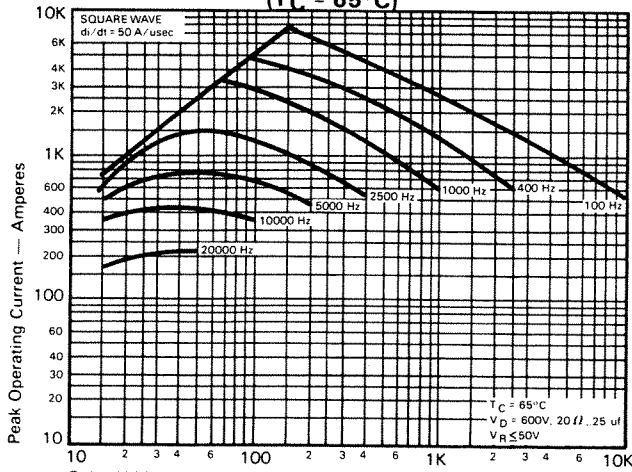

**MAXIMUM ALLOWABLE PEAK ON-STATE CURRENT vs. PULSE WIDTH ( $di/dt = 50\text{A/usec}$ )**

**Trapezoidal Wave Current Data  
( $T_C = 90^\circ\text{C}$ )**

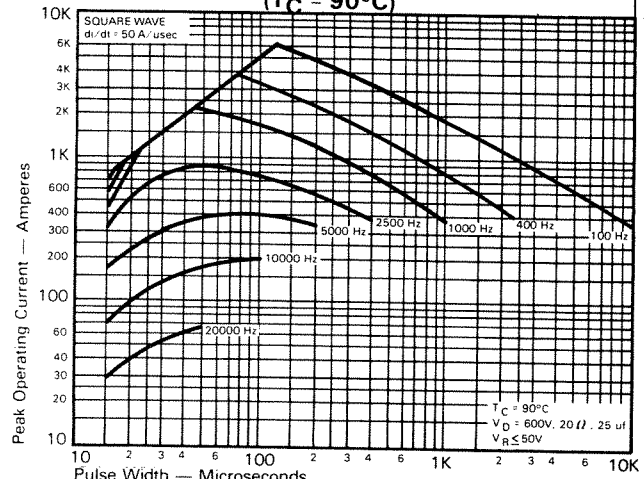

**MAXIMUM ALLOWABLE PEAK ON-STATE CURRENT vs. PULSE WIDTH ( $di/dt = 50\text{A/usec}$ )**

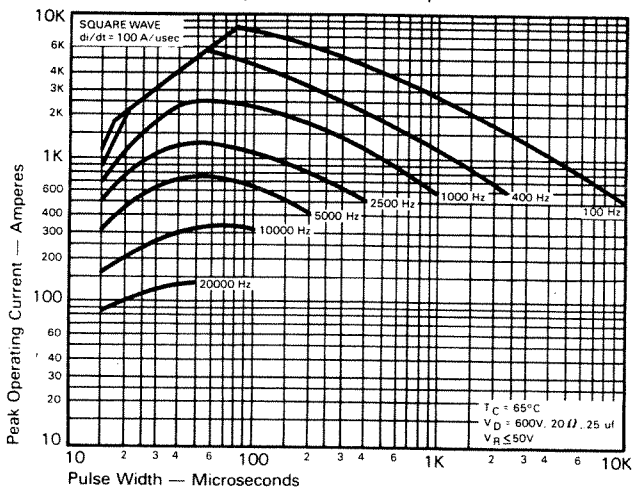

**MAXIMUM ALLOWABLE PEAK ON-STATE CURRENT vs. PULSE WIDTH ( $di/dt = 100\text{A/usec}$ )**

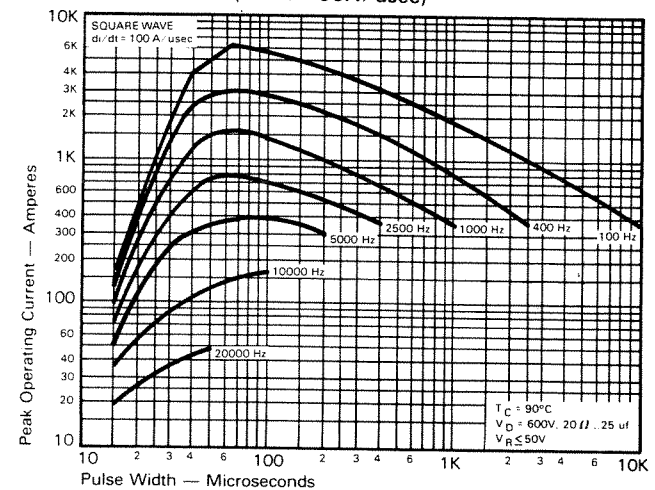

**MAXIMUM ALLOWABLE PEAK ON-STATE CURRENT vs. PULSE WIDTH ( $di/dt = 100\text{A/usec}$ )**

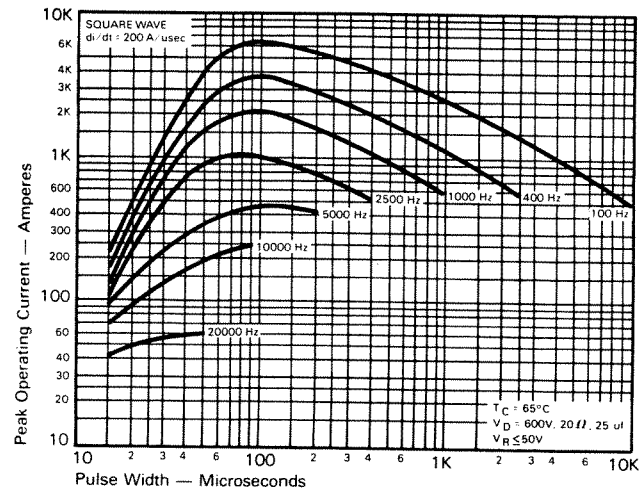

**MAXIMUM ALLOWABLE PEAK ON-STATE CURRENT vs. PULSE WIDTH ( $di/dt = 200\text{A/usec}$ )**

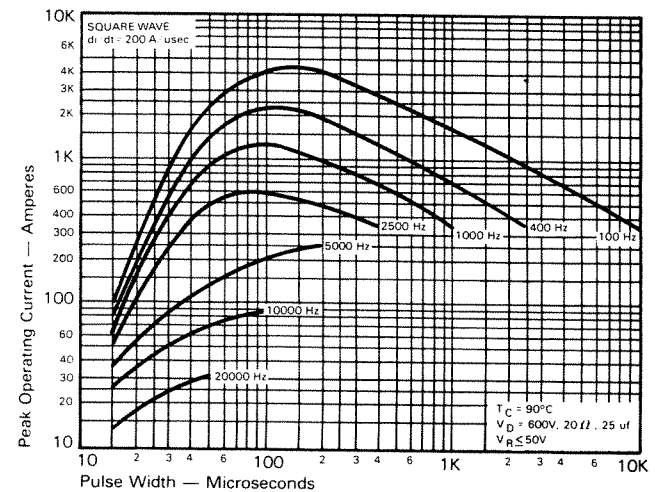

**MAXIMUM ALLOWABLE PEAK ON-STATE CURRENT vs. PULSE WIDTH ( $di/dt = 200\text{A/usec}$ )**

FAST SWITCHING THYRISTORS