

## Thermally-Enhanced High Power RF LDMOS FETs 70 W, 1805 – 1880 MHz

### Description

The PTFA180701E and PTFA180701F are 70-watt LDMOS FETs designed for GSM and GSM EDGE power amplifier applications in the 1805 MHz to 1880 MHz band. Features include input and output matching, and thermally-enhanced packages with slotted or earless flanges. Manufactured with Infineon's advanced LDMOS process, these devices provide excellent thermal performance and superior reliability.

PTFA180701E  
Package H-36265-2

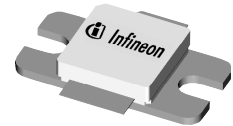

PTFA180701F  
Package H-37265-2

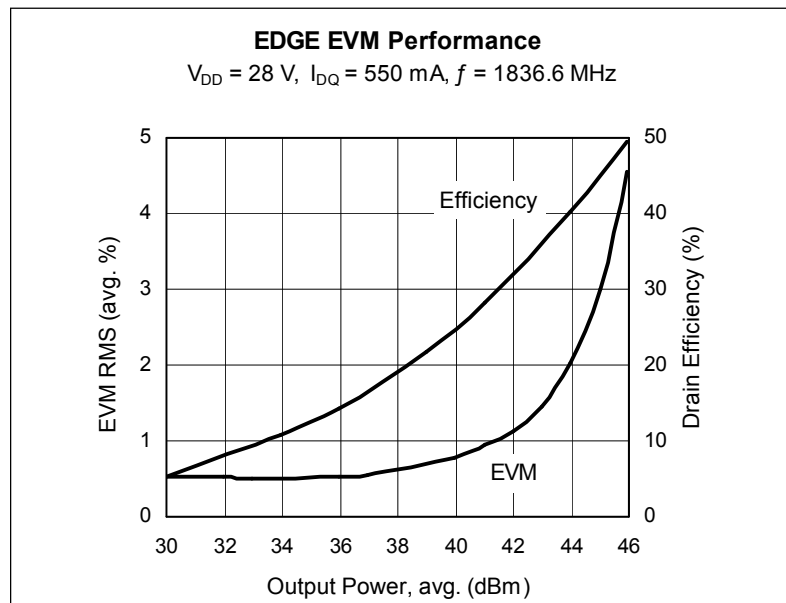

### Features

- Thermally-enhanced packages, Pb-free and RoHS-compliant
- Broadband internal matching
- Typical EDGE performance
  - Average output power = 44 dBm
  - Gain = 16.5 dB
  - Efficiency = 40.5%
  - EVM = 2.0%
- Typical CW performance
  - Output power at P-1dB = 72 W
  - Gain = 15.5 dB
  - Efficiency = 59%
- Integrated ESD protection: Human Body Model, Class 2 (minimum)
- Excellent thermal stability, low HCI drift
- Capable of handling 10:1 VSWR @ 28 V, 70 W (CW) output power

### RF Characteristics

**EDGE Measurements** (not subject to production test—verified by design/characterization in Infineon test fixture)

$V_{DD} = 28\text{ V}$ ,  $I_{DQ} = 550\text{ mA}$ ,  $P_{OUT} = 44\text{ dBm}$ ,  $f = 1836.6\text{ MHz}$

Characteristic		Symbol	Min	Typ	Max	Unit
Error Vector Magnitude		EVM RMS	—	2.0	—	%
Modulation Spectrum	@ 400 kHz	ACPR	—	-62	—	dBc
	@ 600 kHz	ACPR	—	-76	—	dBc
Gain		$G_{ps}$	—	16.5	—	dB
Drain Efficiency		$\eta_D$	—	40.5	—	%

All published data at  $T_{CASE} = 25^\circ\text{C}$  unless otherwise indicated

**ESD:** Electrostatic discharge sensitive device—observe handling precautions!

## RF Characteristics (cont.)

### Two-tone Measurements (tested in Infineon test fixture)

$V_{DD} = 28\text{ V}$ ,  $I_{DQ} = 550\text{ mA}$ ,  $P_{OUT} = 60\text{ W PEP}$ ,  $f = 1840\text{ MHz}$ , tone spacing = 1 MHz

Characteristic	Symbol	Min	Typ	Max	Unit
Gain	$G_{ps}$	15.5	16.5	—	dB
Drain Efficiency	$\eta_D$	44	45	—	%
Intermodulation Distortion	IMD	—	-30	-29	dBc

## DC Characteristics

Characteristic	Conditions	Symbol	Min	Typ	Max	Unit
Drain-Source Breakdown Voltage	$V_{GS} = 0\text{ V}$ , $I_{DS} = 10\text{ mA}$	$V_{(BR)DSS}$	65	—	—	V
Drain Leakage Current	$V_{DS} = 28\text{ V}$ , $V_{GS} = 0\text{ V}$	$I_{DSS}$	—	—	1.0	$\mu\text{A}$
	$V_{DS} = 63\text{ V}$ , $V_{GS} = 0\text{ V}$	$I_{DSS}$	—	—	10.0	$\mu\text{A}$
On-State Resistance	$V_{GS} = 10\text{ V}$ , $V_{DS} = 0.1\text{ V}$	$R_{DS(on)}$	—	0.125	—	$\Omega$
Operating Gate Voltage	$V_{DS} = 28\text{ V}$ , $I_D = 550\text{ mA}$	$V_{GS}$	2.0	2.5	3.0	V
Gate Leakage Current	$V_{GS} = 10\text{ V}$ , $V_{DS} = 0\text{ V}$	$I_{GSS}$	—	—	1.0	$\mu\text{A}$

## Maximum Ratings

Parameter	Symbol	Value	Unit
Drain-Source Voltage	$V_{DSS}$	65	V
Gate-Source Voltage	$V_{GS}$	-0.5 to +12	V
Junction Temperature	$T_J$	200	$^{\circ}\text{C}$
Total Device Dissipation Above 25 $^{\circ}\text{C}$ derate by	$P_D$	201	W
		1.15	W/ $^{\circ}\text{C}$
Storage Temperature Range	$T_{STG}$	-40 to +150	$^{\circ}\text{C}$
Thermal Resistance ( $T_{CASE} = 70^{\circ}\text{C}$ , 70 W CW)	$R_{\theta JC}$	0.87	$^{\circ}\text{C}/\text{W}$

## Ordering Information

Type and Version	Order Code	Package Description	Shipping
PTFA180701E V4 R0	PTFA180701EV4R0XTMA1	H-36265-2, bolt-down	Tape & Reel, 50 pcs
PTFA180701E V4 R250	PTFA180701EV4R250XTMA1	H-36265-2, bolt-down	Tape & Reel, 250 pcs
PTFA180701F V4 R0	PTFA180701FV4R0XTMA1	H-37265-2, earless flange	Tape & Reel, 50 pcs
PTFA180701F V4 R250	PTFA180701FV4R250XTMA1	H-37265-2, earless flange	Tape & Reel, 250 pcs

**Typical Performance** (measurements taken in production test fixture)

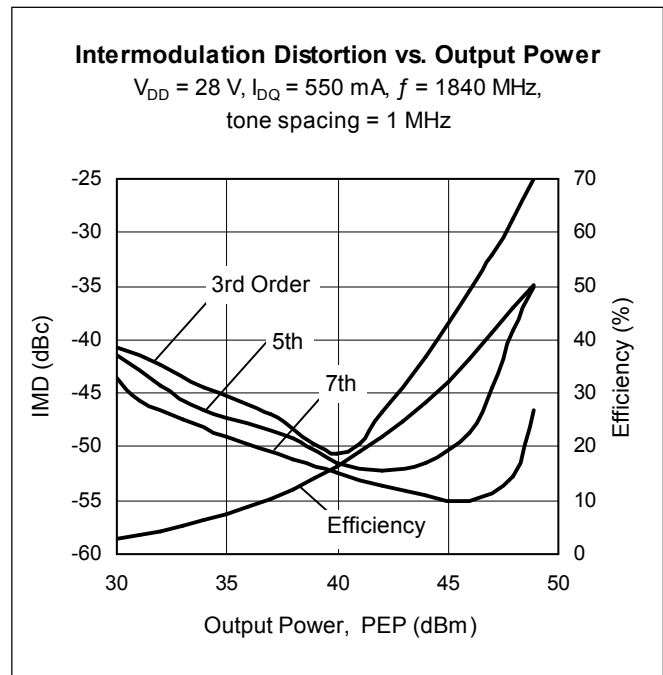
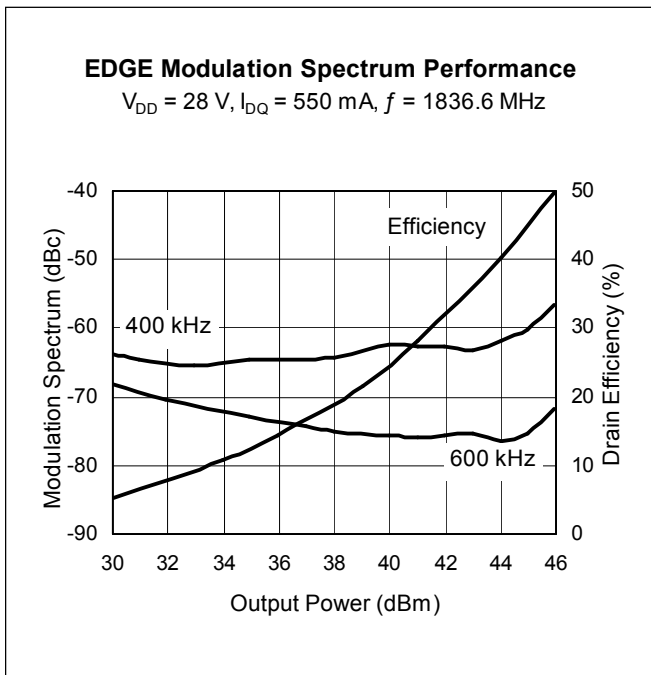
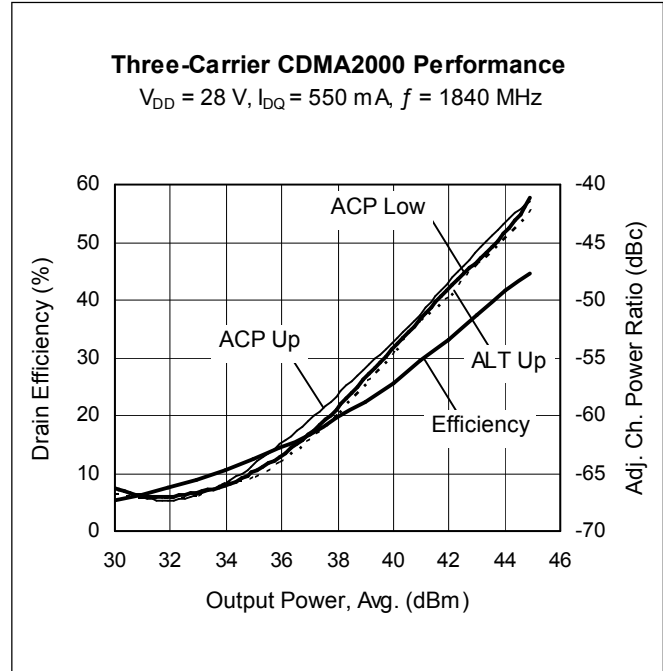
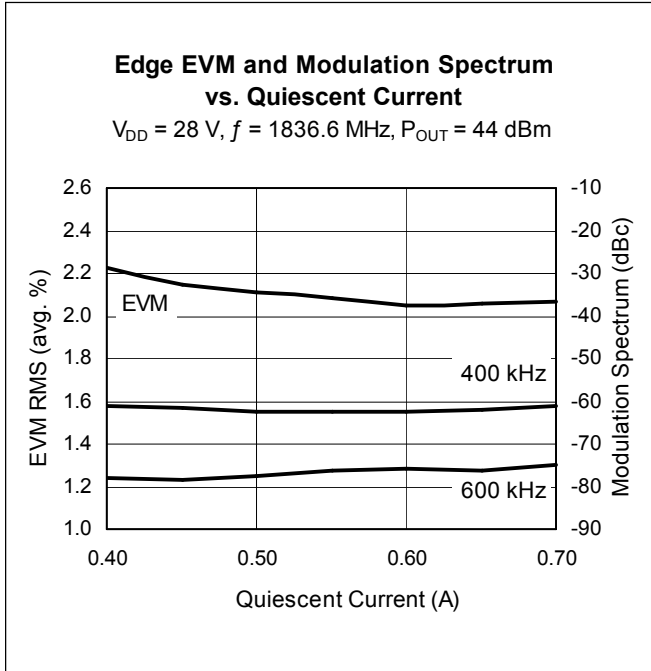

**Typical Performance (cont.)**

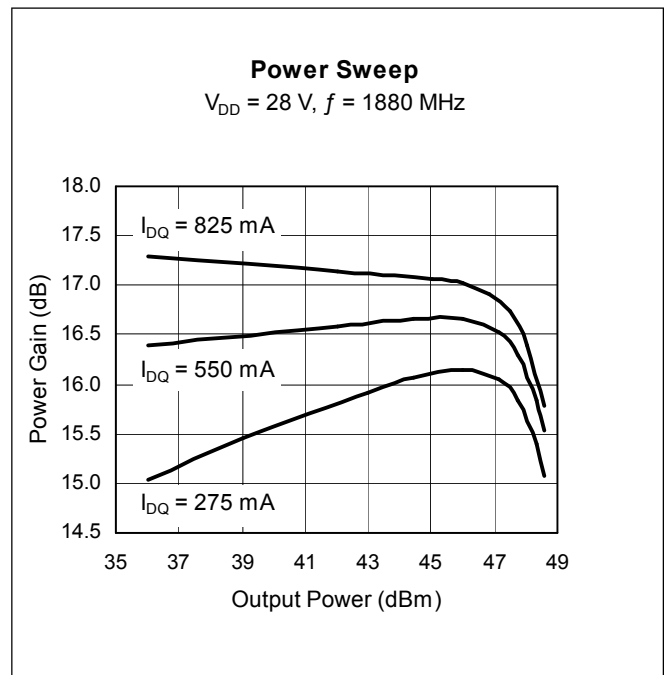
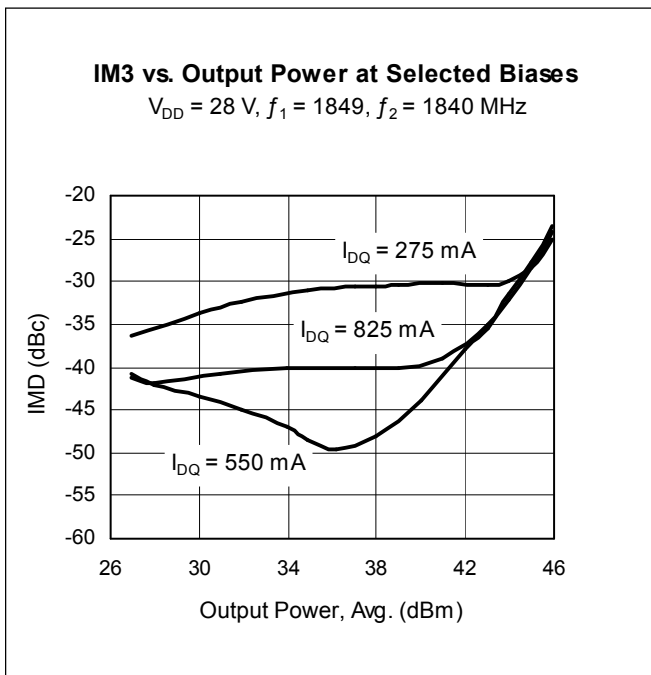
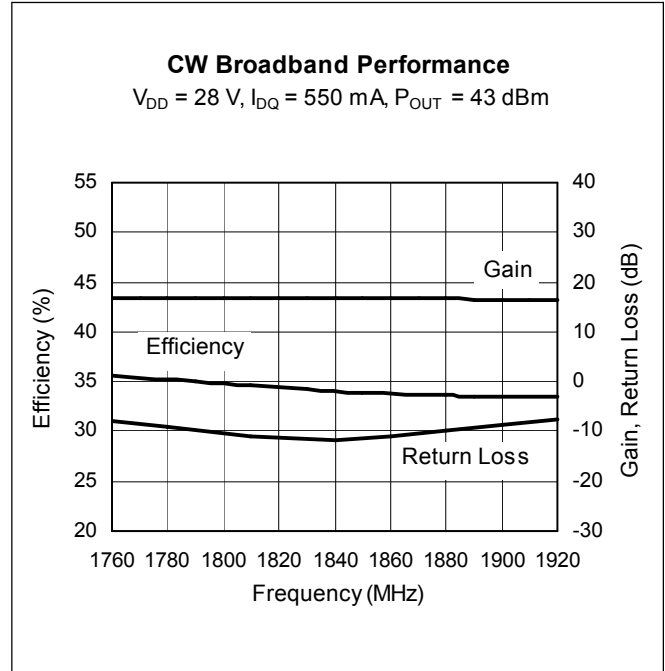
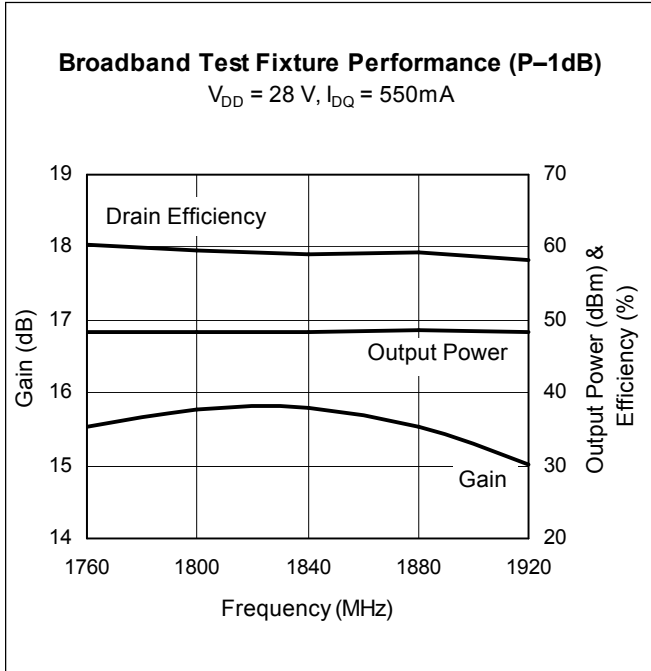

Typical Performance (cont.)

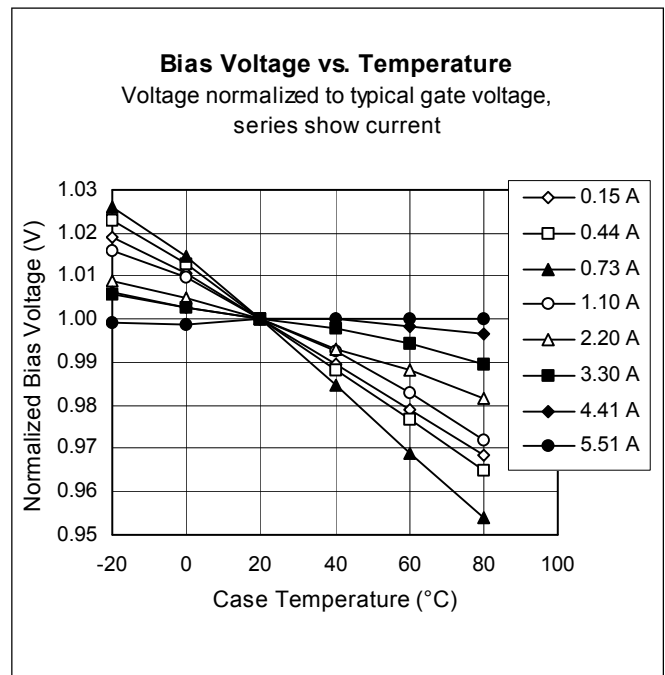
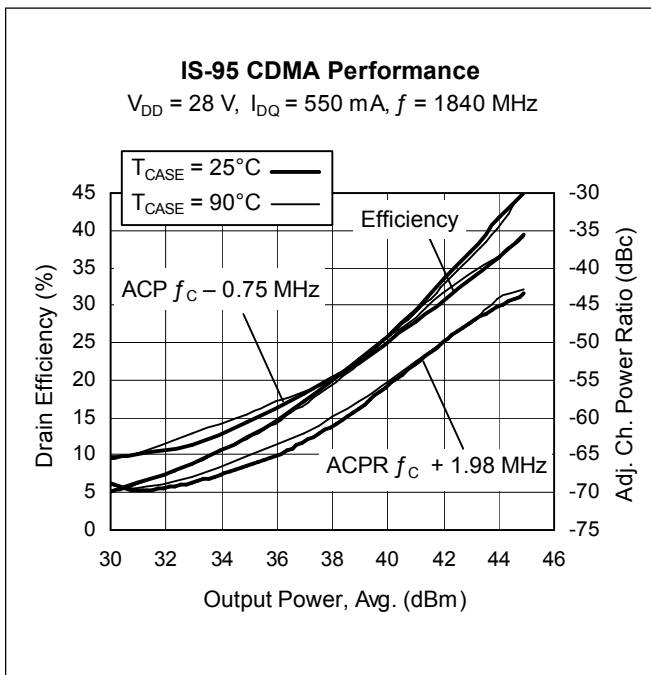
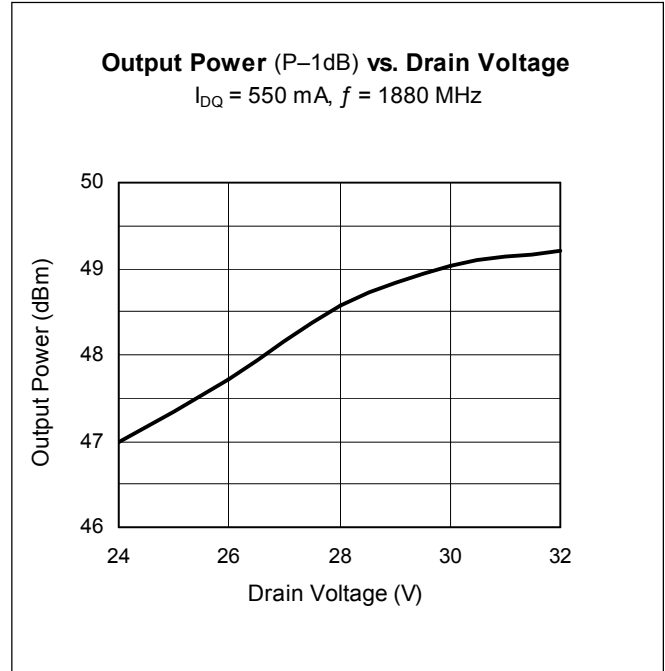
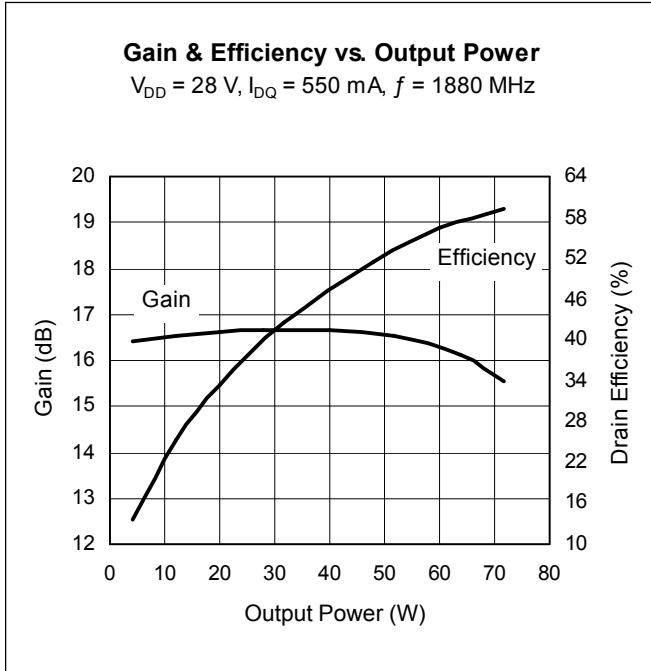

### Broadband Circuit Impedance

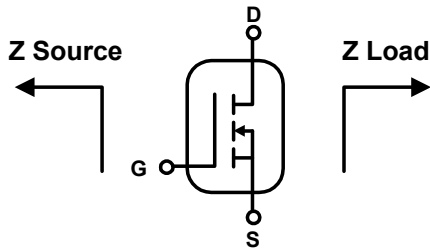

Frequency MHz	Z Source W		Z Load W	
	R	jX	R	jX
1760	7.9	-10.3	4.6	-1.4
1800	7.4	-10.0	4.5	-1.1
1840	7.0	-9.7	4.5	-0.8
1880	6.5	-9.3	4.4	-0.3
1920	6.1	-8.9	4.3	-0.1

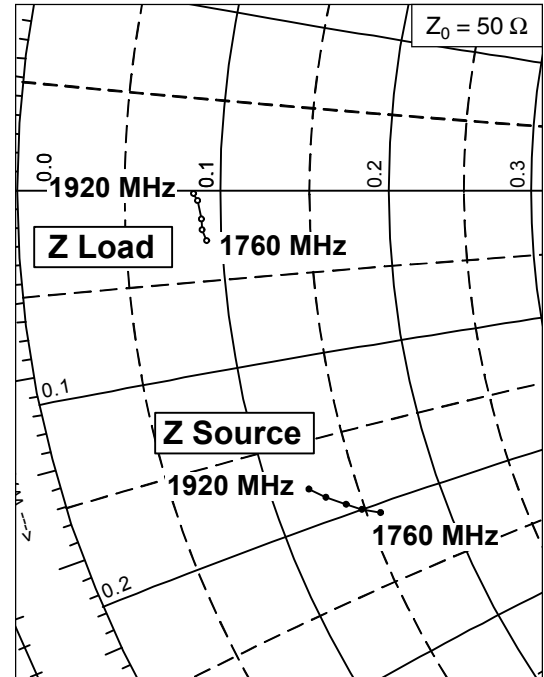

See next page for circuit information

## Reference Circuit

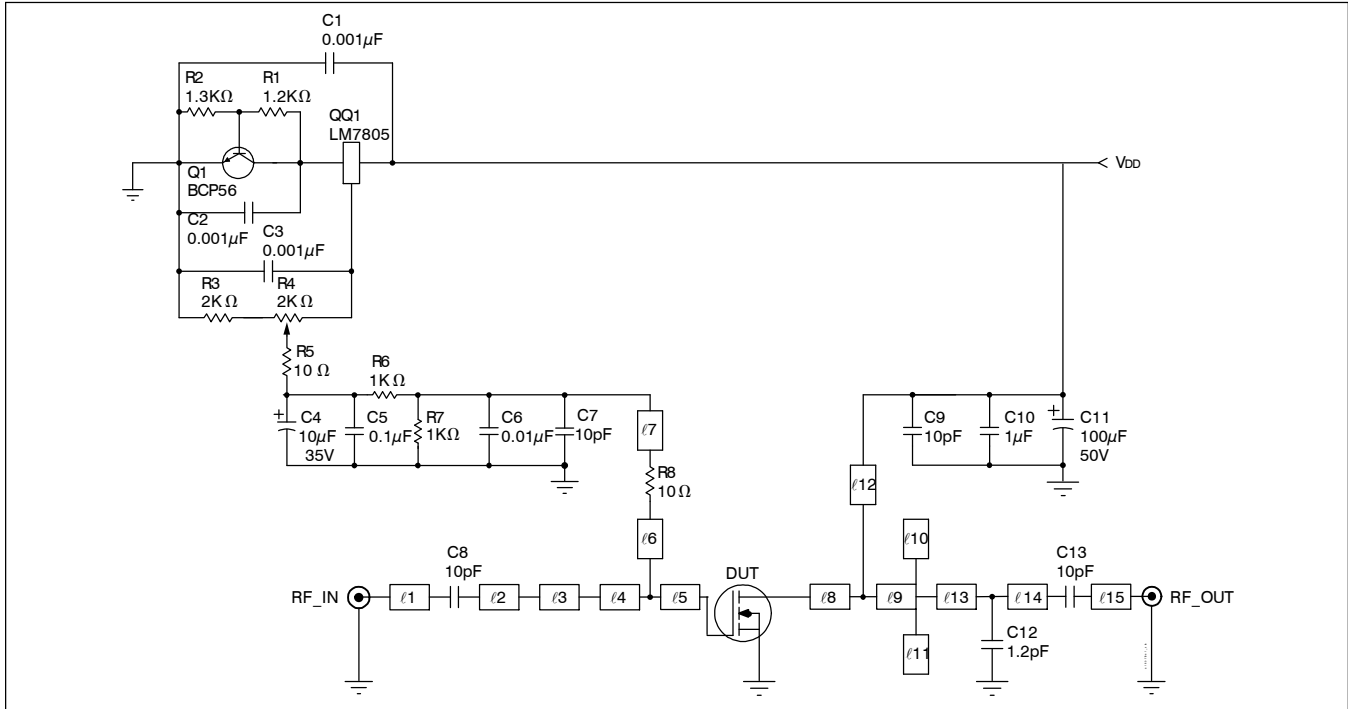

Reference circuit schematic for 1840 MHz

### Circuit Assembly Information

DUT	PTFA180701E or PTFA180701F	LDMOS Transistor	
PCB	0.76 mm [.030"], $\epsilon_r = 3.48$	Rogers, RO4350	1 oz. copper

Microstrip	Electrical Characteristics at 1840 MHz <sup>1</sup>	Dimensions: L x W ( mm )	Dimensions: L x W (in.)
$\ell_1$	0.034 $\lambda$ , 50.0	3.33 x 1.70	0.131 x 0.067
$\ell_2$	0.149 $\lambda$ , 50.0	14.68 x 1.70	0.578 x 0.067
$\ell_3$	0.014 $\lambda$ , 10.2	1.27 x 13.28	0.050 x 0.523
$\ell_4$	0.044 $\lambda$ , 7.1	3.86 x 19.61	0.152 x 0.772
$\ell_5$	0.014 $\lambda$ , 7.1	1.27 x 19.61	0.050 x 0.772
$\ell_6$	0.012 $\lambda$ , 78.0	1.22 x 0.74	0.048 x 0.029
$\ell_7$	0.115 $\lambda$ , 65.0	11.51 x 1.07	0.453 x 0.042
$\ell_8$	0.016 $\lambda$ , 8.9	1.37 x 15.34	0.054 x 0.604
$\ell_9$	0.090 $\lambda$ , 8.9	8.13 x 15.34	0.320 x 0.604
$\ell_{10}, \ell_{11}$	0.020 $\lambda$ , 21.8	1.91 x 5.36	0.075 x 0.211
$\ell_{12}$	0.162 $\lambda$ , 64.0	16.18 x 1.12	0.637 x 0.044
$\ell_{13}$	0.042 $\lambda$ , 50.0	4.11 x 1.70	0.162 x 0.067
$\ell_{14}$	0.074 $\lambda$ , 50.0	7.29 x 1.70	0.287 x 0.067
$\ell_{15}$	0.032 $\lambda$ , 50.0	3.12 x 1.70	0.123 x 0.067

<sup>1</sup>Electrical characteristics are rounded

Reference Circuit (cont.)

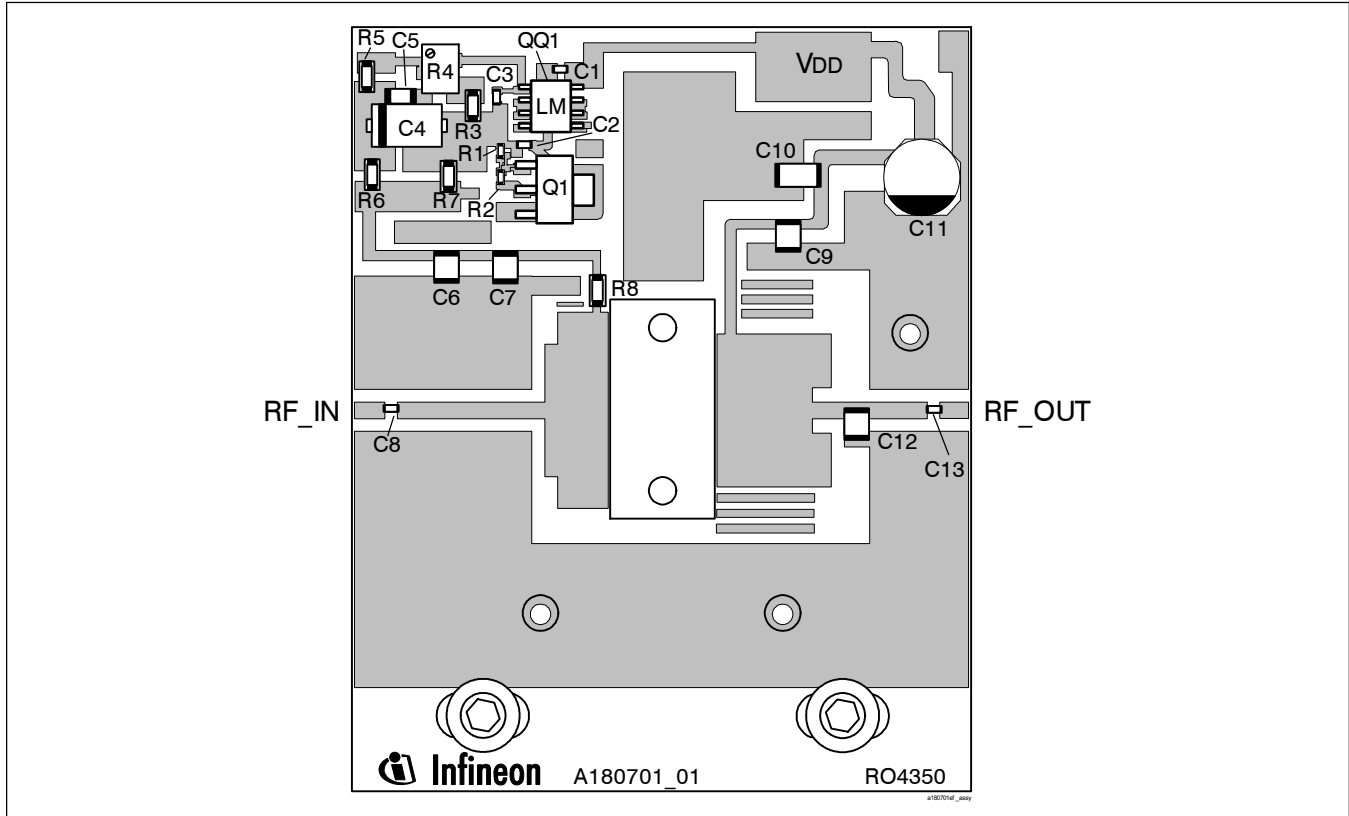

Reference circuit assembly diagram\* (not to scale)

Component	Description	Suggested Manufacturer	P/N or Comment
C1, C2, C3	Capacitor, 0.001 $\mu$ F	Digi-Key	PCC1772CT-ND
C4	Tantalum capacitor, 10 $\mu$ F, 35 V	Digi-Key	399-1655-2-ND
C5	Capacitor, 0.1 $\mu$ F	Digi-Key	PCC104BCT-ND
C6	Capacitor, 0.01 $\mu$ F	ATC	200B 103
C7, C9	Ceramic capacitor, 10 pF	ATC	100B 100
C8, C13	Ceramic capacitor, 10 pF	ATC	100A 100
C10	Ceramic capacitor, 1 $\mu$ F	Digi-Key	445-1411-1-ND
C11	Electrolytic capacitor, 100 $\mu$ F, 50 V	Digi-Key	PCE3718CT-ND
C12	Ceramic capacitor, 1.2 pF	ATC	100B 1R2
Q1	Transistor	Infineon Technologies	BCP56
QQ1	Voltage regulator	National Semiconductor	LM7805
R1	Chip resistor 1.2 k-ohms	Digi-Key	P1.2KGCT-ND
R2	Chip resistor 1.3 k-ohms	Digi-Key	P1.3KGCT-ND
R3	Chip resistor 2 k-ohms	Digi-Key	P2KECT-ND
R4	Potentiometer 2 k-ohms	Digi-Key	3224W-202ETR-ND
R5, R8	Chip resistor 10 ohms	Digi-Key	P10ECT-ND
R6, R7	Chip resistor 1 k-ohms	Digi-Key	P1KECT-ND

\*Gerber files for this circuit available on request.



## Package Outline Specifications

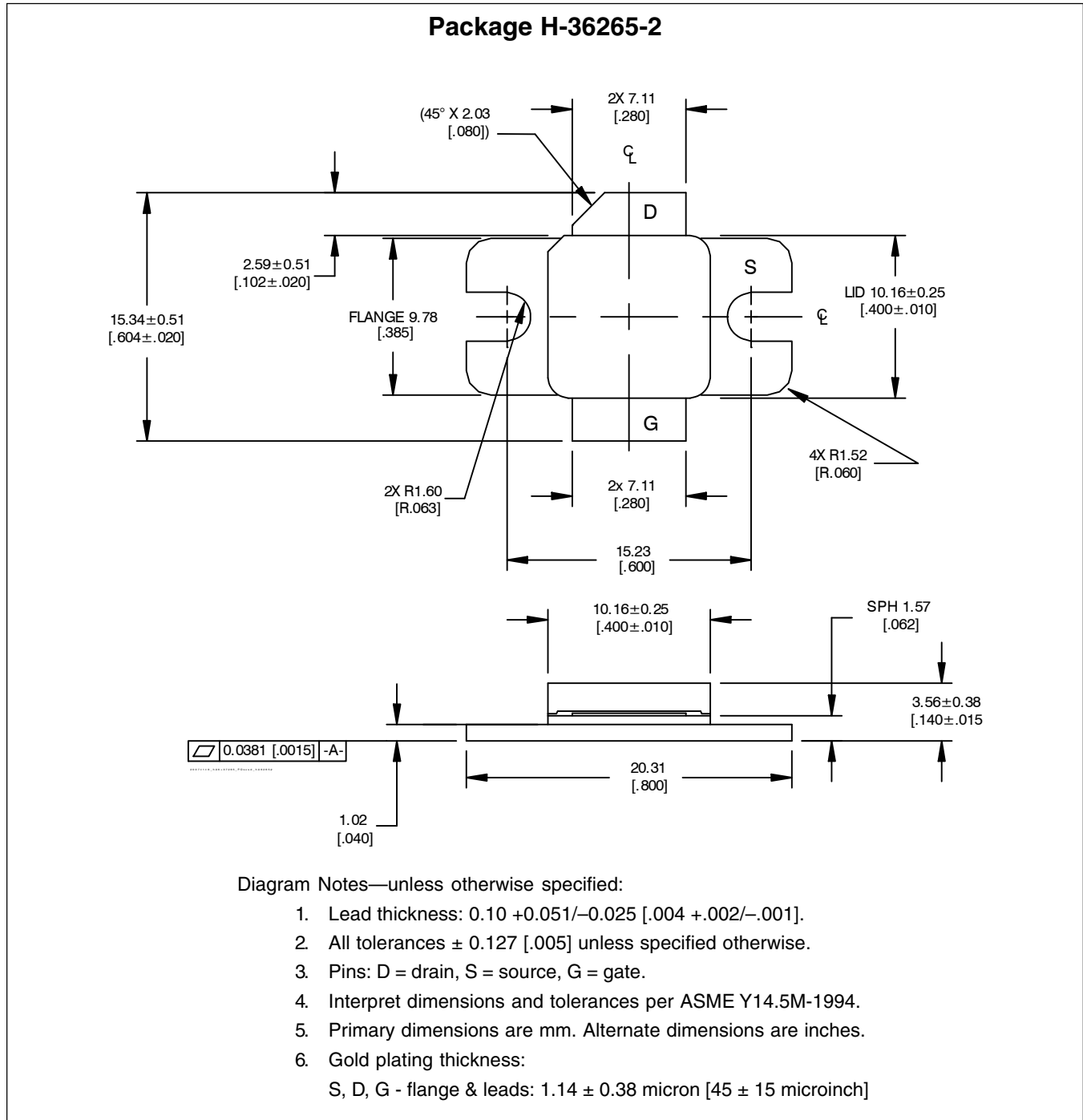

Find the latest and most complete information about products and packaging at the Infineon Internet page  
<http://www.infineon.com/products>

Package Outline Specifications (cont.)

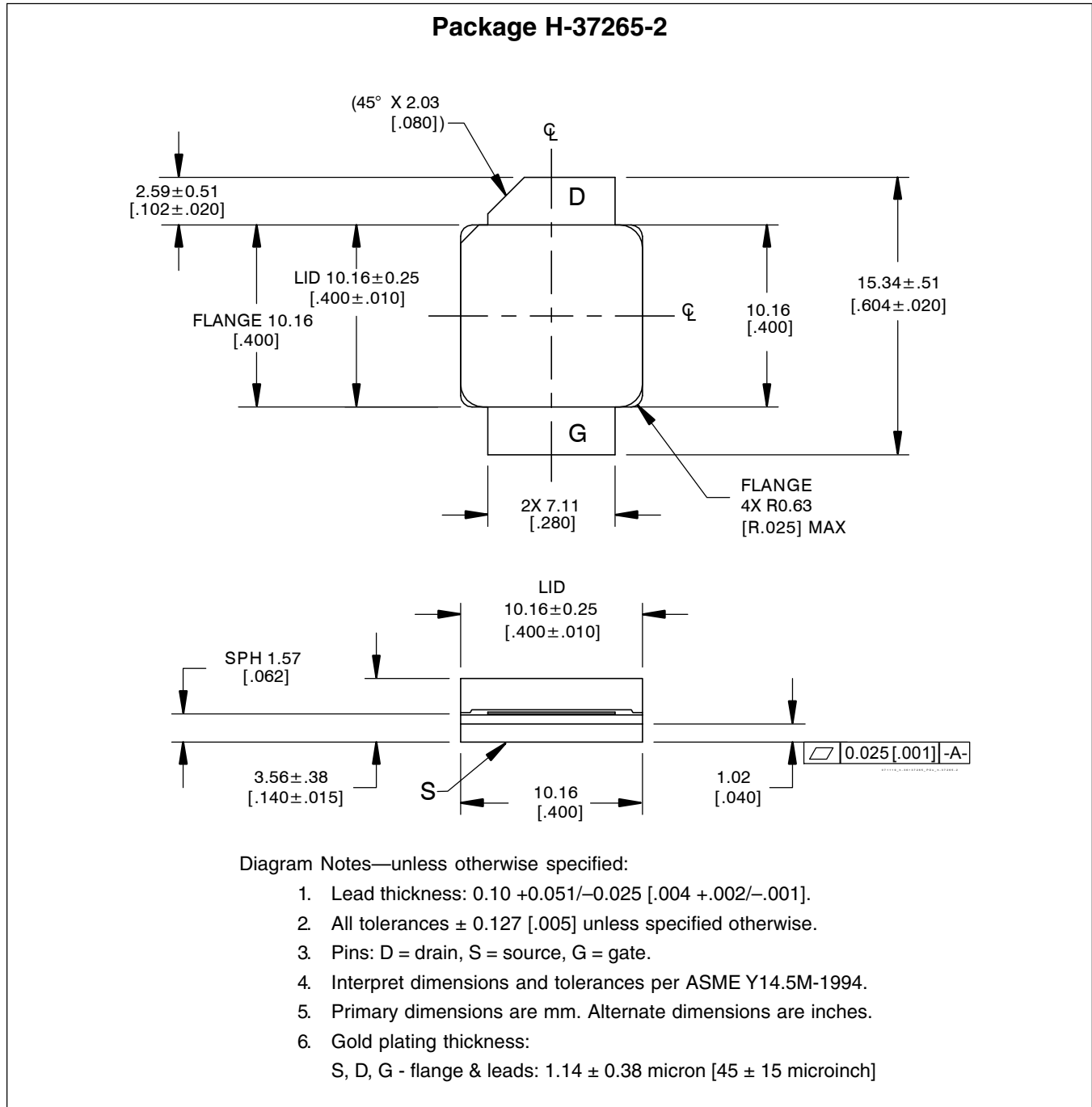

Find the latest and most complete information about products and packaging at the Infineon Internet page  
<http://www.infineon.com/products>

**Revision History:** 2016-06-21

Data Sheet

Previous Version: 2009-02-20, Data Sheet

Page	Subjects (major changes since last revision)
2	Update ordering information

**We Listen to Your Comments**

Any information within this document that you feel is wrong, unclear or missing at all?  
 Your feedback will help us to continuously improve the quality of this document.  
 Please send your proposal (including a reference to this document) to:

[highpowerRF@infineon.com](mailto:highpowerRF@infineon.com)

To request other information, contact us at:  
 +1 877 465 3667 (1-877-GO-LDMOS) USA  
 or +1 408 776 0600 International

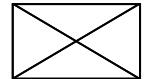
**Edition 2016-06-21****Published by**

**Infineon Technologies AG**  
**81726 Munich, Germany**

**© 2009 Infineon Technologies AG**  
**All Rights Reserved.**

**Legal Disclaimer**

The information given in this document shall in no event be regarded as a guarantee of conditions or characteristics. With respect to any examples or hints given herein, any typical values stated herein and/or any information regarding the application of the device, Infineon Technologies hereby disclaims any and all warranties and liabilities of any kind, including without limitation, warranties of non-infringement of intellectual property rights of any third party.

**Information**

For further information on technology, delivery terms and conditions and prices, please contact the nearest Infineon Technologies Office ([www.infineon.com/rfpower](http://www.infineon.com/rfpower)).

**Warnings**

Due to technical requirements, components may contain dangerous substances. For information on the types in question, please contact the nearest Infineon Technologies Office.

Infineon Technologies components may be used in life-support devices or systems only with the express written approval of Infineon Technologies, if a failure of such components can reasonably be expected to cause the failure of that life-support device or system or to affect the safety or effectiveness of that device or system. Life support devices or systems are intended to be implanted in the human body or to support and/or maintain and sustain and/or protect human life. If they fail, it is reasonable to assume that the health of the user or other persons may be endangered.