

#### PROTECTION PRODUCTS - TransClamp™

#### Description

A TransClamp™ is a low capacitance TVS array designed to protect high speed data interfaces. This series has been specifically designed to protect sensitive components which are connected to data and transmission lines from overvoltage caused by **ESD** (electrostatic discharge), **CDE** (Cable Discharge Events), and **Lightning**.

These devices integrate low capacitance, surge-rated compensation diodes with a high power transient voltage suppressor (TVS). The compensation diodes are arranged in a bridge pattern allowing the device to be connected in common mode and/or differential mode. This allows the designer maximum flexibility and reduces parts count. The capacitance of the device is limited to 12pF maximum from line-to-line to ensure correct signal transmission on high-speed lines.

These devices may be used to meet Telcordia GR-1089-CORE short-haul (intra-building) surge requirements and will withstand a minimum 100 A surge for a 2/10µs pulse.

The TClamp™2502N is in a 10-pin, RoHS/WEEE compliant, SLP2626P10 package. It measures 2.6 x 2.6 x 0.60mm. The leads are spaced at a pitch of 0.5mm and are finished with lead-free NiPdAu. They are particularly well suited for applications where board space is at a premium such as integrated connectors/magnetics and carrier class Ethernet equipment.

#### Features

- ◆ Transient protection for high-speed data lines to **Bellcore 1089 (Intra-Building) 100A (2/10µs)**  
**IEC 61000-4-2 (ESD) ±15kV (air), ±8kV (contact)**  
**IEC 61000-4-4 (EFT) 40A (5/50ns)**  
**IEC 61000-4-5 (Lightning) L5, 95A (8/20µs)**
- ◆ Low capacitance (12pF line-to-line)
- ◆ Low operating voltages (**2.5V**)
- ◆ Low clamping voltage
- ◆ Small SLP Package saves board space
- ◆ Solid-state technology

#### Mechanical Characteristics

- ◆ SLP2626P10 10L package
- ◆ RoHS/WEEE Compliant
- ◆ Nominal Dimensions: 2.6 x 2.6 x 0.60 mm
- ◆ Lead Pitch: 0.5mm
- ◆ Molding compound flammability rating: UL 94V-0
- ◆ Marking: Marking Code + Date Code
- ◆ Packaging: Tape and Reel per EIA 481

#### Applications

- ◆ Ethernet
- ◆ T3/E3
- ◆ Integrated Magnetics
- ◆ Carrier Class Equipment
- ◆ Customer Premise Equipment

#### Circuit Diagram

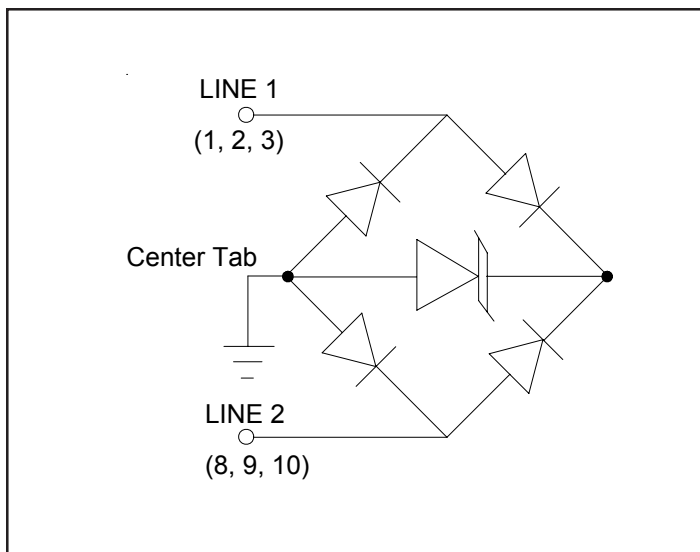

#### Package Configuration

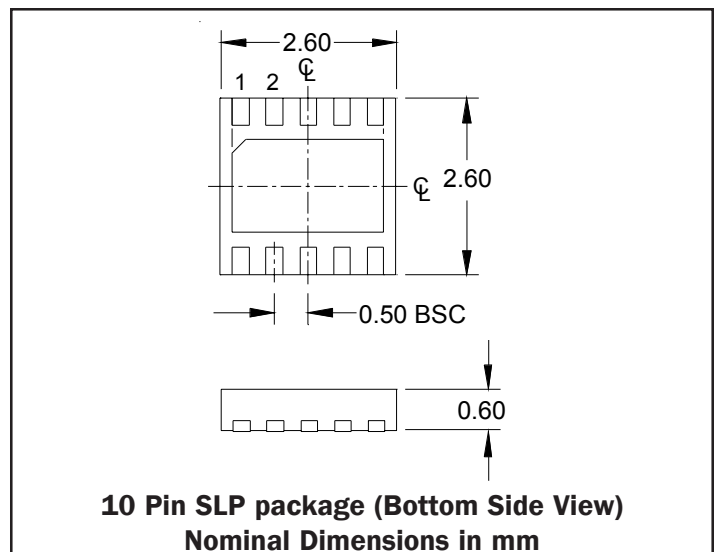

**PROTECTION PRODUCTS**
**Absolute Maximum Rating**

Rating	Symbol	Value	Units
Peak Pulse Power (tp = 2/10µs)	$P_{pk}$	2500	Watts
Peak Pulse Current (tp = 2/10µs)	$I_{pp}$	120	A
Peak Pulse Current (tp = 8/20µs)	$I_{pp}$	95	A
ESD per IEC 61000-4-2 (Air) ESD per IEC 61000-4-2 (Contact)	$V_{ESD}$	30 30	kV
Operating Temperature	$T_J$	-40 to +85	°C
Storage Temperature	$T_{STG}$	-55 to +150	°C

**Electrical Characteristics (T=25°C unless otherwise specified)**

<b>TClamp2502N</b>						
Parameter	Symbol	Conditions	Minimum	Typical	Maximum	Units
Reverse Stand-Off Voltage	$V_{RWM}$	T=25°C to 85°C			2.5	V
Punch-Through Voltage	$V_{PT}$	$I_{PT} = 2\mu A$ T=25°C	2.7			V
Snap-Back Voltage	$V_{SB}$	$I_{SB} = 50mA$	2.0			V
Reverse Leakage Current	$I_R$	$V_{RWM} = 2.5V$ , T=25°C			0.5	µA
Clamping Voltage	$V_C$	$I_{pp} = 100A$ , tp = 2/10µs Line-to-Ground			17	V
Clamping Voltage	$V_C$	$I_{pp} = 100A$ , tp = 2/10µs Line-to-Line			25	V
Junction Capacitance	$C_J$	Between I/O pins and Gnd $V_R = 0V$ , f = 1MHz			25	pF
		Between I/O pins $V_R = 0V$ , f = 1MHz			12	pF

## PROTECTION PRODUCTS

### Typical Characteristics

#### Non-Repetitive Peak Pulse Power vs. Pulse Time

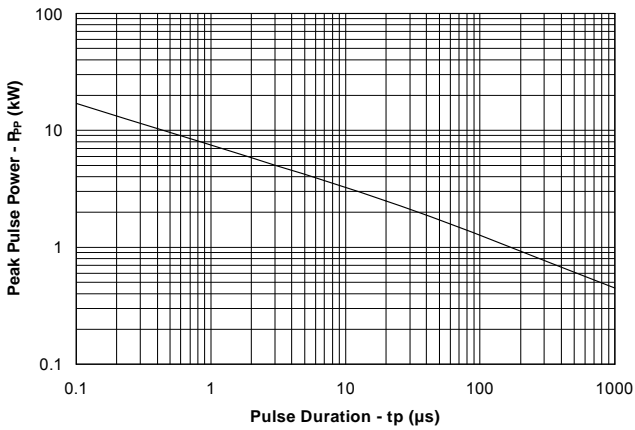

#### Power Derating Curve

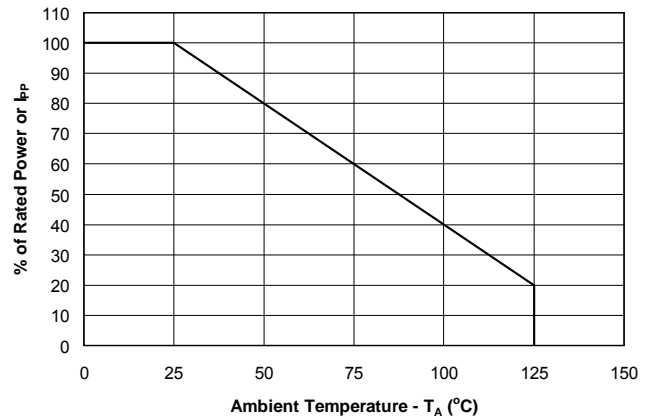

#### Normalized Junction Capacitance vs. Reverse Voltage (Line-to-Line)

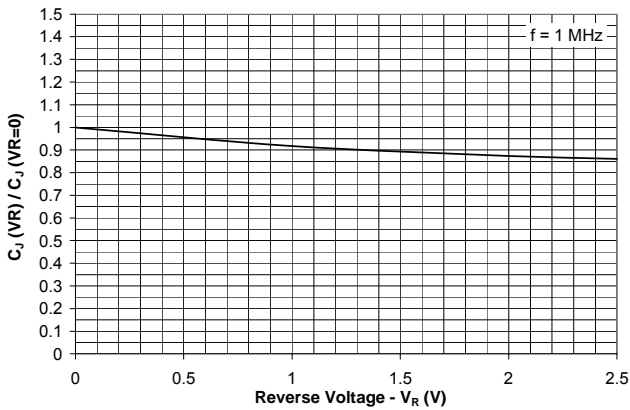

#### Normalized Junction Capacitance vs. Reverse Voltage (Line-to-Ground)

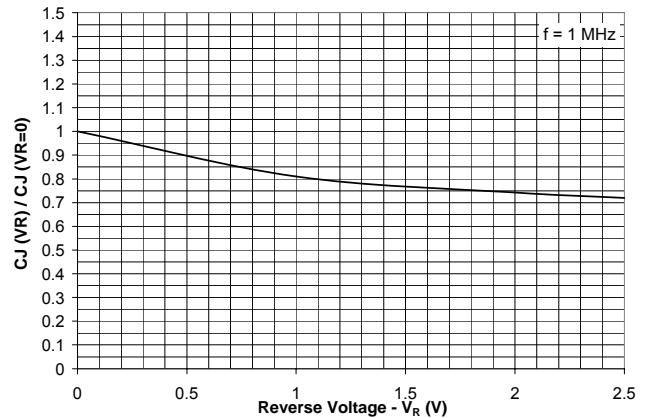

#### Clamping Voltage vs. Peak Pulse Current

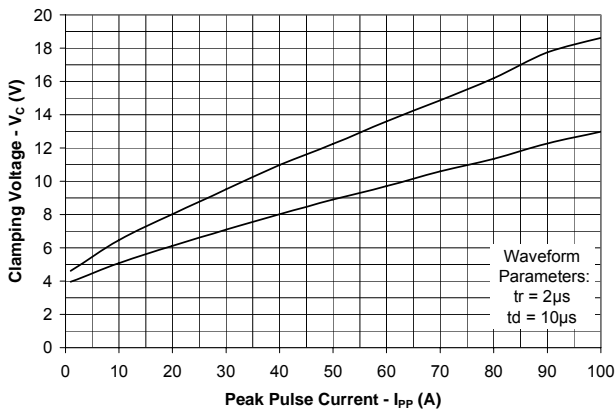

## PROTECTION PRODUCTS

### Typical Characteristics

**Typical Insertion Loss S21 (Each Line)**

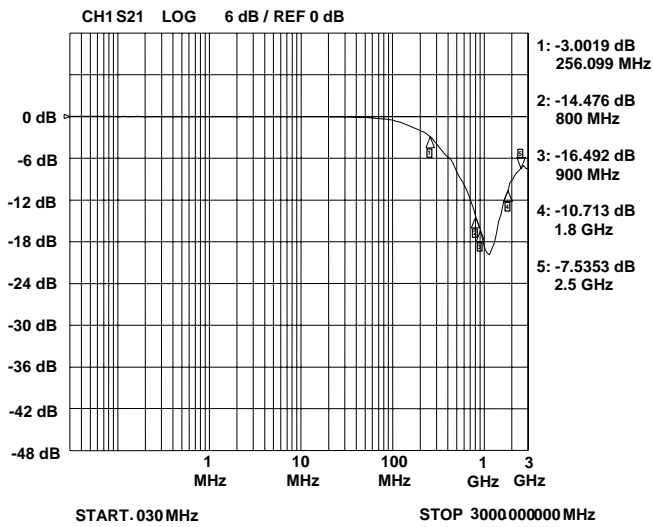

**Analog Crosstalk (Each Line)**

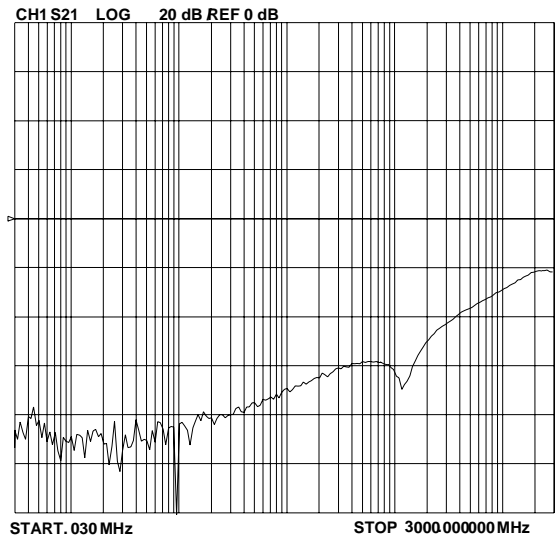

**ESD Clamping (+8kV per IEC 61000-4-2)**

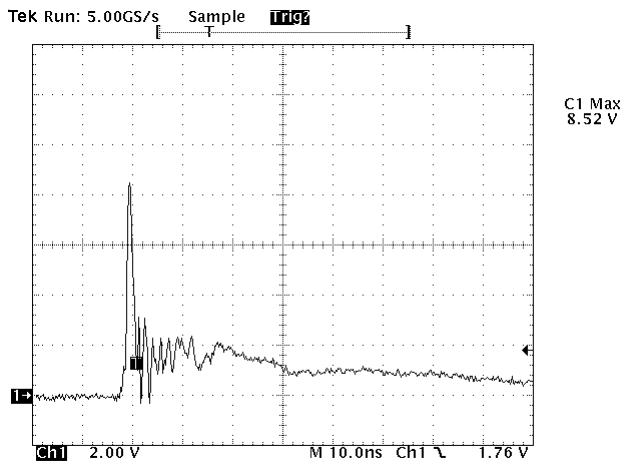

**ESD Clamping (-8kV per IEC 61000-4-2)**

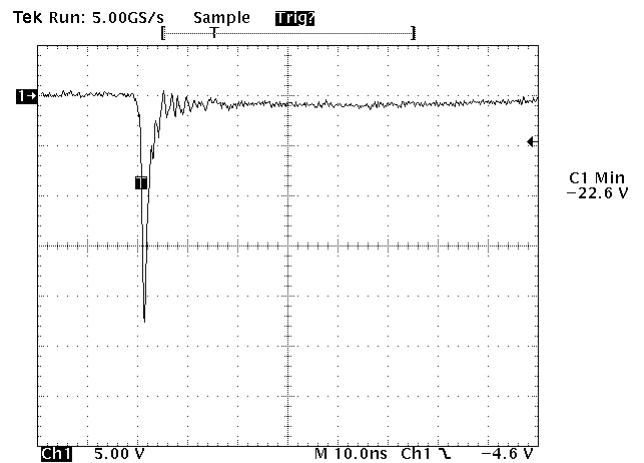

Note: Data is taken with a 10x attenuator

Note: Data is taken with a 10x attenuator

## PROTECTION PRODUCTS

### Applications Information

#### Device Connection Options for Protection of Two High-Speed Data Lines

TClamp2502N is designed to protect two high-speed data lines (one differential pair) from transient over-voltages which result from lightning and ESD. They can be configured to protect in differential (Line-to-Line) and common (Line-to-Ground) mode. Data line inputs/outputs are connected at pins 1, 2 and 3, and 8, 9 and 10 as shown. For proper operation, pins 1 - 3 must be connected together and pins 8 - 10 must be connected together. Pins 4, 5, 6, and 7 may be left unconnected. For differential operation, the center tab is also left not connected. For common mode operation, the center tab is connected to ground. The ground connection should be made directly to a ground plane on the board for best results. The use of multiple vias is recommended for reduced ground loop inductance.

**Circuit Diagram**

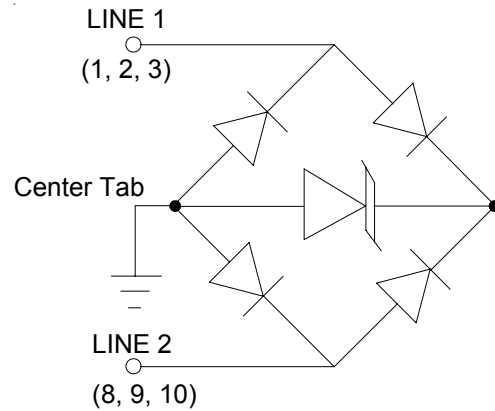

**Pin Configuration (Top Side View)**

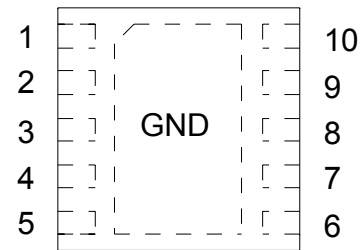

Pin	Identification
1, 2, 3	Line 1 in/out
8, 9, 10	Line 2 in/out
4, 5, 6, 7	No Connect
Center Tab	Ground

PROTECTION PRODUCTS

Applications Information - Spice Model

TClamp2502N Spice Model & Parameters

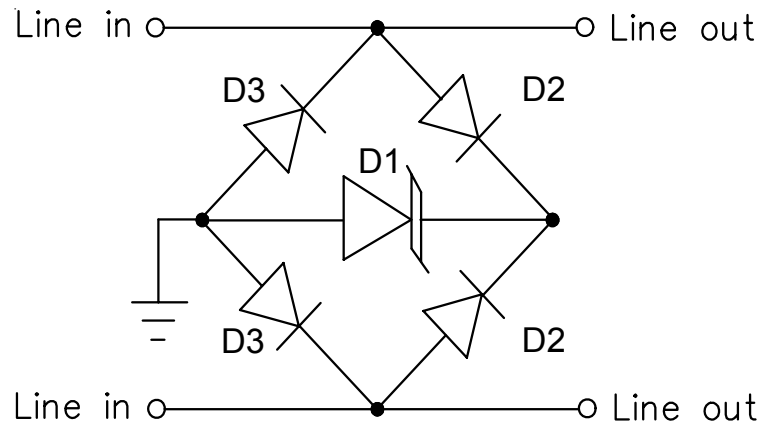

TClamp2502N Spice Model

Table 1 - TClamp2502N Spice Parameters				
Parameter	Unit	D1 (TVS)	D2 (LCRD)	D3 (LCRD)
IS	Amp	1.4E-11	1.001E-20	1.001E-20
BV	Volt	2.8	150	150
VJ	Volt	8	0.59	0.59
RS	Ohm	0.015	0.075	0.05
IBV	Amp	1E-3	1E-3	1E-3
CJO	Farad	400e-12	11.0E-12	11.0E-12
TT	sec	2.541E-9	2.541E-9	2.541E-9
M	--	0.256	0.01	0.01
N	--	1.1	1.1	1.1
EG	eV	1.11	1.11	1.11

PROTECTION PRODUCTS

Outline Drawing - SLP2626P10

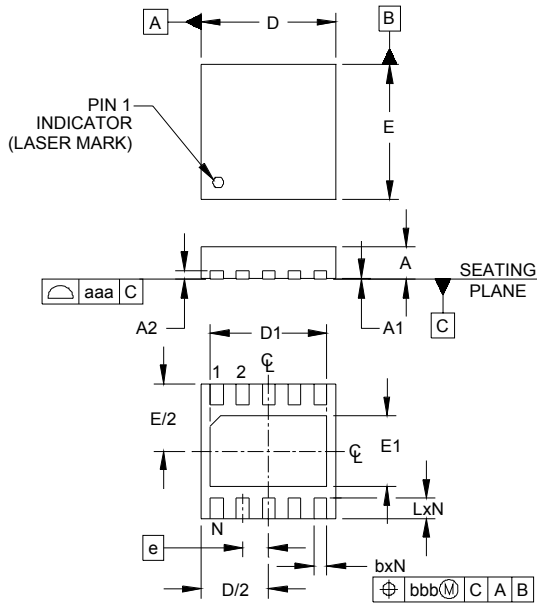

DIM	DIMENSIONS					
	INCHES			MILLIMETERS		
	MIN	NOM	MAX	MIN	NOM	MAX
A	.020	.024	.026	0.50	0.60	0.65
A1	.000	.001	.002	0.00	0.03	0.05
A2	(.007)			(0.17)		
b	.007	.010	.012	0.20	0.25	0.30
D	.098	.102	.106	2.50	2.60	2.70
D1	.079	.085	.089	2.00	2.15	2.25
E	.098	.102	.106	2.50	2.60	2.70
E1	.044	.050	.054	1.11	1.26	1.36
e	.020 BSC			0.50 BSC		
L	.011	.014	.016	0.30	0.35	0.40
N	10			10		
aaa	.003			0.08		
bbb	.004			0.10		

NOTES:

1. CONTROLLING DIMENSIONS ARE IN MILLIMETERS (ANGLES IN DEGREES).
2. COPLANARITY APPLIES TO THE EXPOSED PAD AS WELL AS THE TERMINALS.

Land Pattern - SLP2626P10

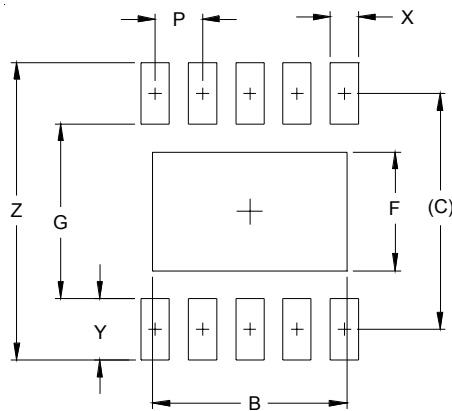

DIM	DIMENSIONS	
	INCHES	MILLIMETERS
B	.081	2.05
C	.100	2.50
F	.050	1.26
G	.073	1.85
P	.020	0.50
X	.012	0.30
Y	.025	0.65
Z	.124	3.15

NOTES:

1. THIS LAND PATTERN IS FOR REFERENCE PURPOSES ONLY. CONSULT YOUR MANUFACTURING GROUP TO ENSURE YOUR COMPANY'S MANUFACTURING GUIDELINES ARE MET.

## PROTECTION PRODUCTS

### Marking

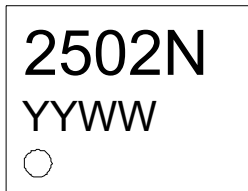

YY = year  
WW = Week

### Ordering Information

Part Number	Qty per Reel	Reel Size
TClamp2502N.TCT	3,000	7 Inch

Note: Lead finish is lead-free NiPdAu

TransClamp and TClamp are marks of Semtech Corporation

### Tape and Reel Specification

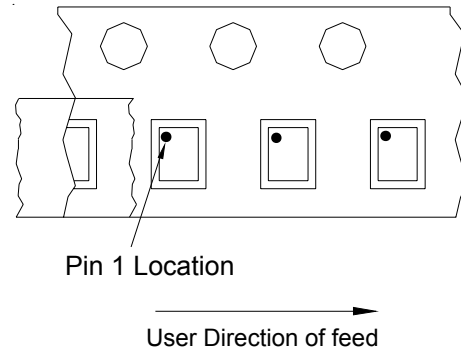
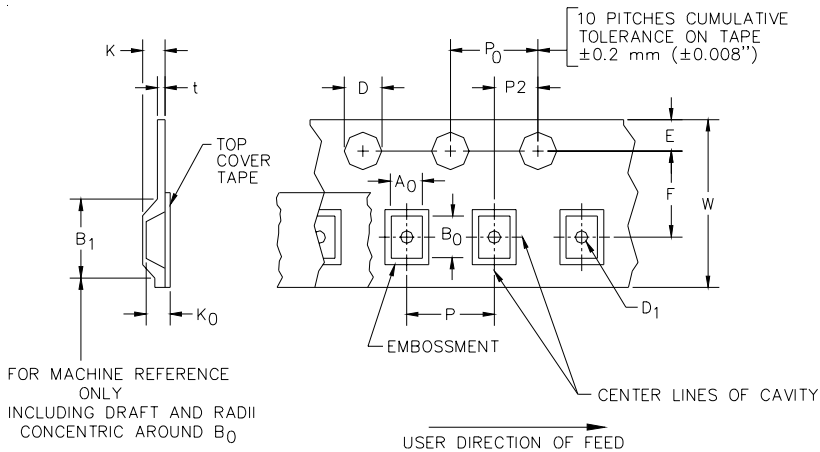

### Device Orientation in Tape

A0	B0	K0
2.77 +/-0.05 mm	2.77 +/-0.05 mm	0.80 +/-0.05 mm

Tape Width	B, (Max)	D	D1	E	F	K (MAX)	P	P0	P2	T(MAX)	W
8 mm	4.2 mm (.165)	1.5 + 0.1 mm - 0.0 mm	1.0 mm ±0.05	1.750±.10 mm	3.5±0.05 mm	2.4 mm	4.0±0.1 mm	4.0±0.1 mm	2.0±0.05 mm	0.4 mm	8.0 mm + 0.3 mm - 0.1 mm

### Contact Information

Semtech Corporation  
 Protection Products Division  
 200 Flynn Rd., Camarillo, CA 93012  
 Phone: (805)498-2111 FAX (805)498-3804