



Parameter	Rating	Units
Blocking Voltage	250	V _P
Load Current	0.7	A _{rms} / A _{DC}
On-Resistance (max)	1.4	Ω

Features

- Handle Load Currents Up to 0.7 A_{DC}/A_{rms}
- 2500V_{rms} Input/Output Isolation
- Power SIP Package
- High Reliability
- No Moving Parts
- Low Drive Power Requirements (TTL/CMOS Compatible)
- Arc-Free With No Snubbing Circuits
- No EMI/RFI Generation
- Machine Insertable, Wave Solderable

Applications

- Industrial Controls
- Motor Control
- Robotics
- Medical Equipment—Patient/Equipment Isolation
- Instrumentation
 - Multiplexers
 - Data Acquisition
 - Electronic Switching
 - I/O Subsystems
- Meters (Watt-Hour, Water, Gas)
- IC Equipment
- Home Appliances

Description

IXYS Integrated Circuits Division and IXYS have combined to bring OptoMOS® technology, reliability, and compact size to a new family of high-power, solid state relays. As part of that family, the CPC1926 is a single-pole, normally open (1-Form-A) solid state relay.

The CPC1926 employs optically coupled MOSFET technology to provide 2500V_{rms} of input to output isolation. The optically coupled outputs, that use patented OptoMOS architecture, are controlled by a highly efficient GaAIAs infrared LED. The combination of low on-resistance and high load-current handling capabilities makes the relay suitable for a variety of high-performance switching applications.

Approvals

- UL 508 Certified Component: File E69938

Ordering Information

Part #	Description
CPC1926Y	4-Pin (8-Pin Body) Power SIP Package (25 per tube)

Pin Configuration

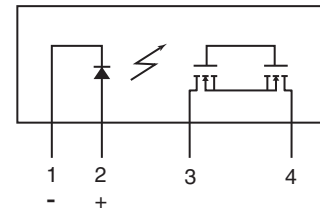

Switching Characteristics of Normally Open Devices

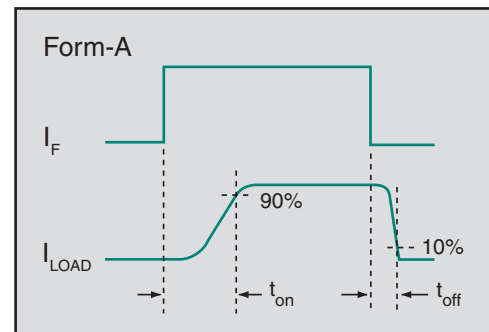

Absolute Maximum Ratings @ 25°C

Parameter	Ratings	Units
Blocking Voltage	250	V _P
Reverse Input Voltage	5	V
Input control Current	50	mA
Peak (10ms)	1	A
Input Power Dissipation ¹	150	mW
Isolation voltage Input to Output	2500	V _{rms}
Operational Temperature	-40 to +85	°C
Storage Temperature	-40 to +125	°C

¹ Derate linearly 3.33 mW / °C

Absolute Maximum Ratings are stress ratings. Stresses in excess of these ratings can cause permanent damage to the device. Functional operation of the device at conditions beyond those indicated in the operational sections of this data sheet is not implied.

Electrical Characteristics @ 25°C

Parameter	Conditions	Symbol	Min	Typ	Max	Units
Output Characteristics						
Load Current, Continuous	Free air	I _L	-	-	0.7	A _{rms} / A _{DC}
Peak Load Current	t ≤ 10ms	I _{LPK}	-	-	±3	A _P
On-Resistance ¹	I _L =100mA	R _{ON}	-	1.2	1.4	Ω
Off-State Leakage Current	V _L =250V _P	I _{LEAK}	-	-	1	μA
Switching Speeds						
Turn-On	I _F =10mA, V _L =10V	t _{on}	-	2.3	10	ms
Turn-Off		t _{off}	-	0.022	10	
Output Capacitance	V _L =50V, f=1MHz	C _{OUT}	-	60	-	pF
Input Characteristics						
Input Control Current to Activate	I _L =120mA	I _F	-	3.75	10	mA
Input Control Current to Deactivate	-	I _F	0.6	-	-	mA
Input Voltage Drop	I _F =5mA	V _F	0.9	1.2	1.4	V
Reverse Input Current	V _R =5V	I _R	-	-	10	μA
Input/Output Characteristics						
Capacitance Input/Output	f=1MHz	C _{IO}	-	2	-	pF

¹ Measurement taken within 1 second of on-time.

Thermal Characteristics

Parameter	Conditions	Symbol	Min	Typ	Max	Units
Thermal Resistance (junction to case)	-	R _{θJC}	-	1.5	-	°C/W

PERFORMANCE DATA*

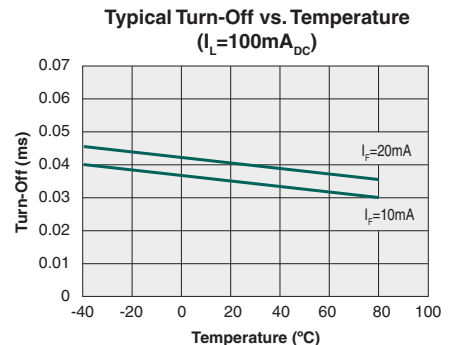
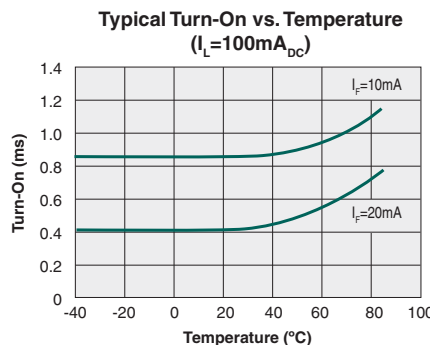
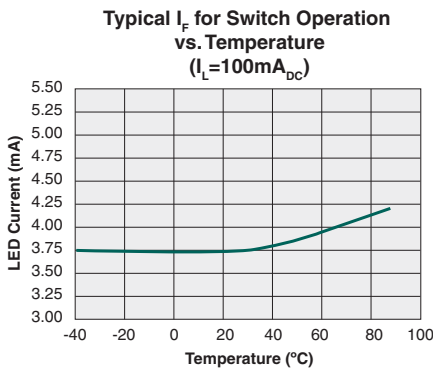
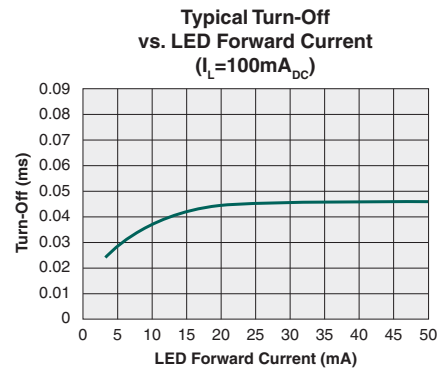
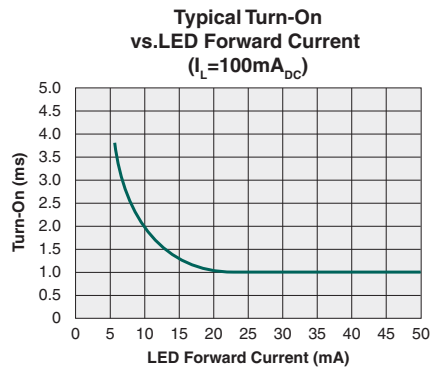
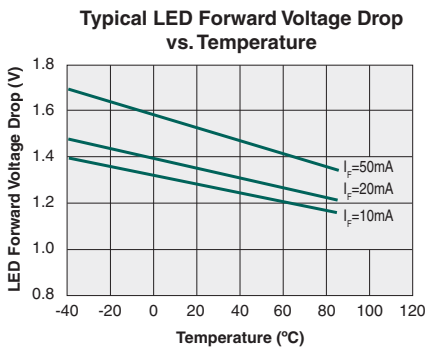
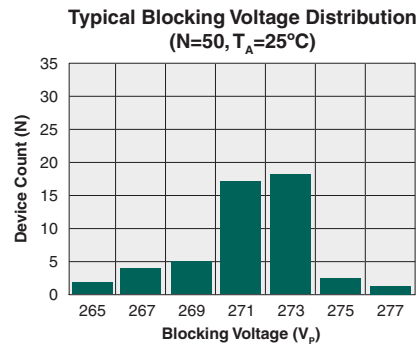
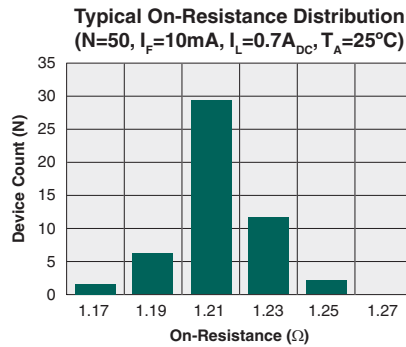
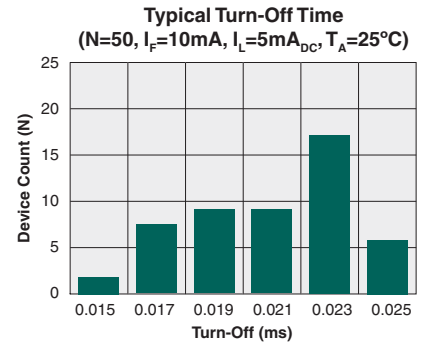
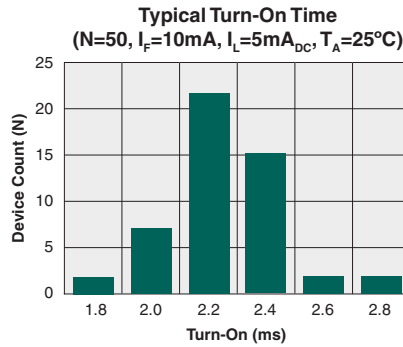
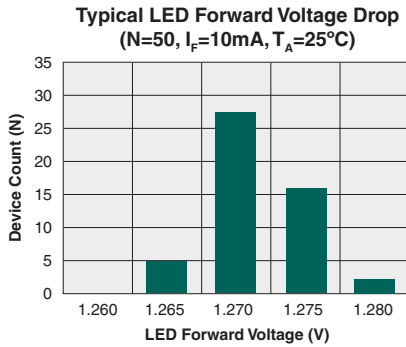

*The Performance data shown in the graphs above is typical of device performance. For guaranteed parameters not indicated in the written specifications, please contact our application department.

PERFORMANCE DATA*

Typical On-Resistance vs. Temperature
($I_F=10\text{mA}$, $I_L=100\text{mA}_{DC}$)

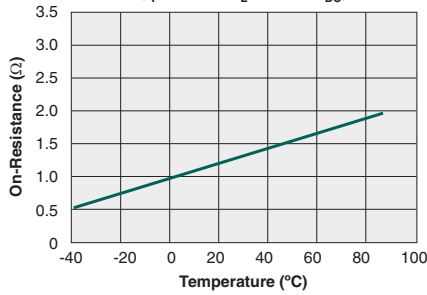

Typical Load Current vs. Load Voltage
($I_F=10\text{mA}$, $T_A=25^\circ\text{C}$)

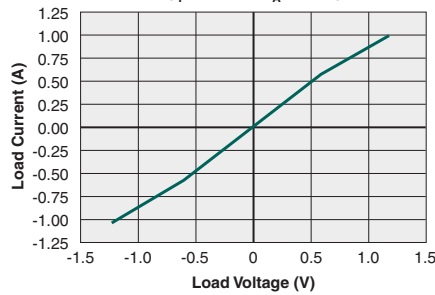

Maximum Load Current vs. Temperature

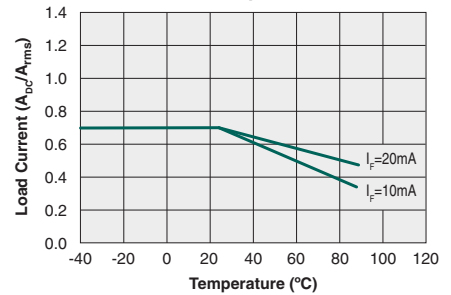

Blocking Voltage vs. Temperature

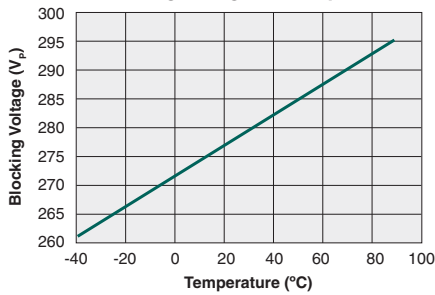

Typical Leakage vs. Temperature
Measured across Pins 3 & 4
($V_L=250\text{V}$)

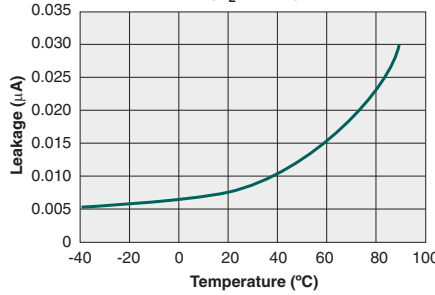

Energy Rating Curve
Free Air, No Heat Sink

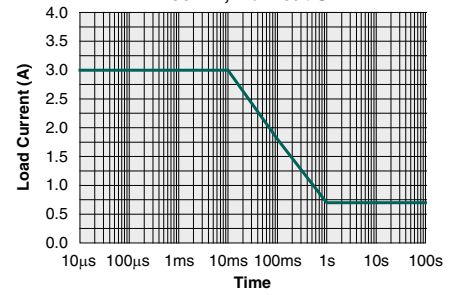

*The Performance data shown in the graphs above is typical of device performance. For guaranteed parameters not indicated in the written specifications, please contact our application department.

Manufacturing Information

Moisture Sensitivity



All plastic encapsulated semiconductor packages are susceptible to moisture ingress. IXYS Integrated Circuits Division classified all of its plastic encapsulated devices for moisture sensitivity according to the latest version of the joint industry standard, **IPC/JEDEC J-STD-020**, in force at the time of product evaluation. We test all of our products to the maximum conditions set forth in the standard, and guarantee proper operation of our devices when handled according to the limitations and information in that standard as well as to any limitations set forth in the information or standards referenced below.

Failure to adhere to the warnings or limitations as established by the listed specifications could result in reduced product performance, reduction of operable life, and/or reduction of overall reliability.

This product carries a **Moisture Sensitivity Level (MSL) rating** as shown below, and should be handled according to the requirements of the latest version of the joint industry standard **IPC/JEDEC J-STD-033**.

Device	Moisture Sensitivity Level (MSL) Rating
CPC1926Y	MSL 1

ESD Sensitivity



This product is **ESD Sensitive**, and should be handled according to the industry standard **JESD-625**.

Reflow Profile

This product has a maximum body temperature and time rating as shown below. All other guidelines of **J-STD-020** must be observed.

Device	Maximum Temperature x Time
CPC1926Y	245°C for 30 seconds

Board Wash

IXYS Integrated Circuits Division recommends the use of no-clean flux formulations. However, board washing to remove flux residue is acceptable. Since IXYS Integrated Circuits Division employs the use of silicone coating as an optical waveguide in many of its optically isolated products, the use of a short drying bake could be necessary if a wash is used after solder reflow processes. Chlorine- or Fluorine-based solvents or fluxes should not be used. Cleaning methods that employ ultrasonic energy should not be used.



MECHANICAL DIMENSIONS

CPC1926Y

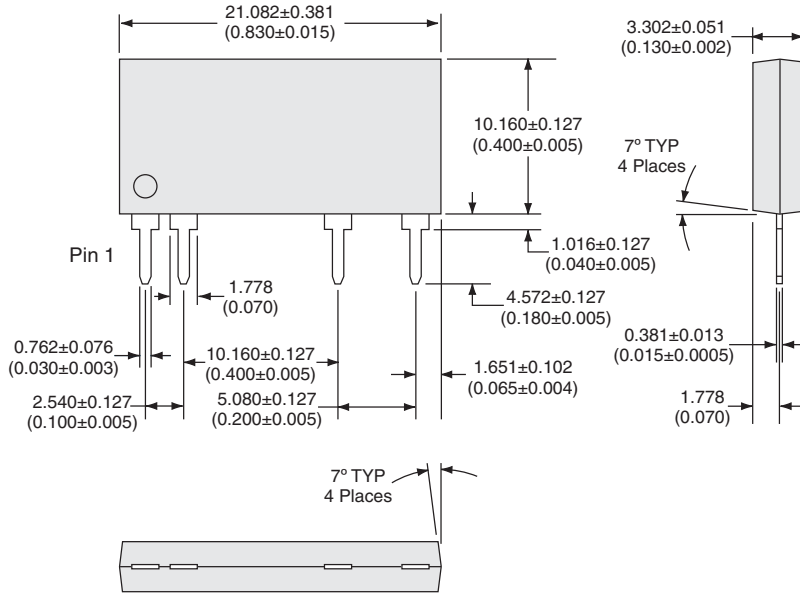

PCB Hole Pattern

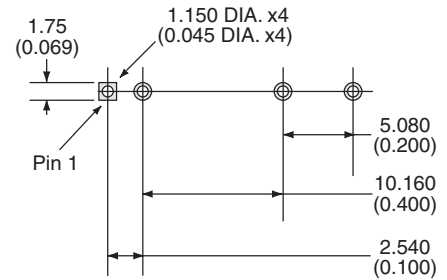

Dimensions
mm
(inches)

For additional information please visit our website at: www.ixysic.com

IXYS Integrated Circuits Division makes no representations or warranties with respect to the accuracy or completeness of the contents of this publication and reserves the right to make changes to specifications and product descriptions at any time without notice. Neither circuit patent licenses nor indemnity are expressed or implied. Except as set forth in IXYS Integrated Circuits Division's Standard Terms and Conditions of Sale, IXYS Integrated Circuits Division assumes no liability whatsoever, and disclaims any express or implied warranty, relating to its products including, but not limited to, the implied warranty of merchantability, fitness for a particular purpose, or infringement of any intellectual property right.

The products described in this document are not designed, intended, authorized or warranted for use as components in systems intended for surgical implant into the body, or in other applications intended to support or sustain life, or where malfunction of IXYS Integrated Circuits Division's product may result in direct physical harm, injury, or death to a person or severe property or environmental damage. IXYS Integrated Circuits Division reserves the right to discontinue or make changes to its products at any time without notice.

Specification: DS-CPC1926-R06
 ©Copyright 2012, IXYS Integrated Circuits Division
 OptoMOS® is a registered trademark of IXYS Integrated Circuits Division
 All rights reserved. Printed in USA.
 12/17/2012